



# Corrosion and Cracking of Supercritical Water Cooled Reactor Materials

**Prof. Le-Fu ZHANG**

Shanghai Jiao Tong University, China

**31 August 2023**



Idaho National Laboratory



# Corrosion and Cracking of Supercritical Water Cooled Reactor Materials

**Prof. Le-Fu ZHANG**

Shanghai Jiao Tong University, China

**31 August 2023**



## Meet the Presenters

**Dr. LeFu Zhang**, Professor at the School of Nuclear Science and Engineering of Shanghai Jiao Tong University, received his Bachelor, Master and Ph.D degrees in material science from Huazhong University of Science and Technology.

His research focuses on materials and water chemistry for light water reactors. He established a joint research laboratory for corrosion of nuclear power materials with Shanghai Nuclear Engineering Research and Design Institute in 2008.

Under his 15 years of leadership, 80 high temperature and pressure water circulating loops have been built for general corrosion, stress corrosion cracking, fretting wear, fuel cladding tube performance and water chemistry tests, among them 15 systems are for supercritical fluid reactors.

He is the Chinese representative in Materials and Chemistry Project Management Board, and the Chinese substitute representative in System Steering Committee of Supercritical Water-Cooled Reactor Systems in Generation IV International Forum (GIF).



# Background



# Supercritical Water Cooled Reactor (SCWR)

One of the six Gen IV concept reactors:

- GFR, LFR, MSR, **SCWR**, SFR and VHTR

A high capacity power reactor in Gen IV for a power plant

- High outlet temperature up to 560°C, thermal efficiency up to 45% (comparing with 35% of PWR), and 10 times higher fuel efficiency

Simplified design + industrial mature turbine

- Direct thermal cycle, no steam generator
- Relatively smaller dimensions of reactor vessel, main steam line, containment, turbine, ...
- Turbine is readily available and up to 650°C
- Passive core cooling systems from Gen III PWRs
- Low cost

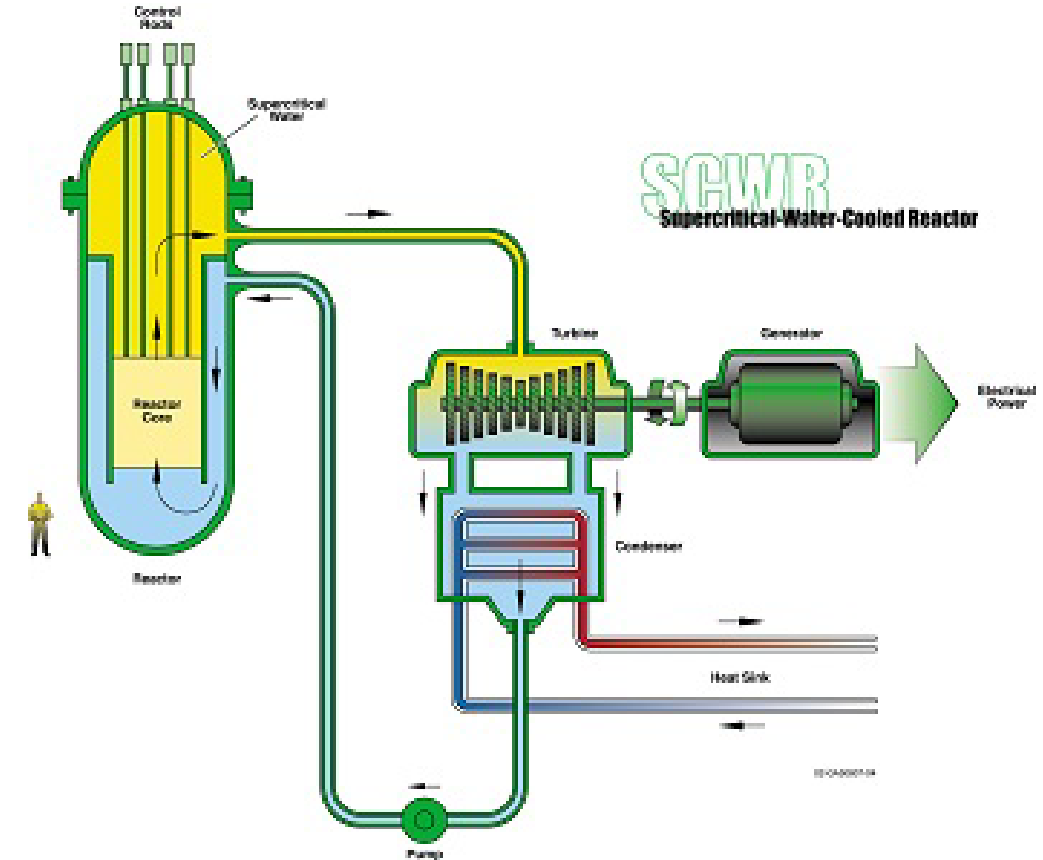

**SCWR – the best GEN IV conceptual design for electric power plant**

CRDM

SCW

High integrity  
Creep/SCC/FAC

Fuel cladding:  $T_{max} = 550, 650, 800^{\circ}C$   
(No candidate yet)

Internals:  $T_{max} = 500, 600^{\circ}C$

P boundary :  $\sim 30MPa$

RV design : 2.25Cr1Mo ?

PT design : F/M steel

High  $T$  Creep  
Corrosion  
SCC/IASCC  
Irradiation  
High integrity

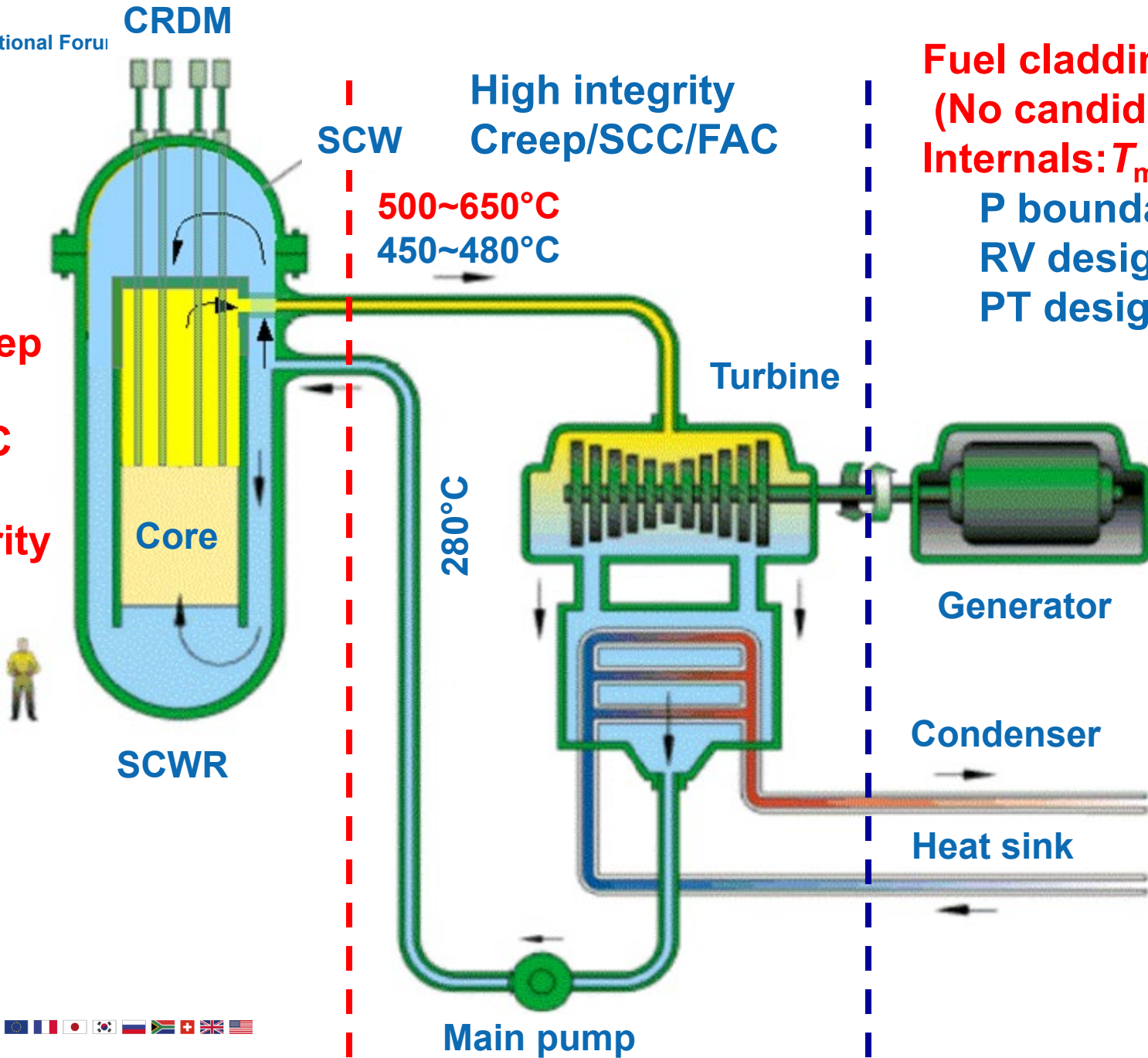

Fuel cladding material controls the coolant outlet temperature

Manufacturing of reactor pressure vessel is a great challenge

Reducing outlet temperature is necessary for a demo SCWR

# Characteristics of SCW

- SC point: 374°C/22.1MPa
- Density: ~ 0.1g/cm<sup>3</sup>
- High density nonpolar gas
- Mix with oxygen with any percentage
- Very high solubility of organic materials
- Very low solubility of ionic compounds

**Very oxidizing gas!**

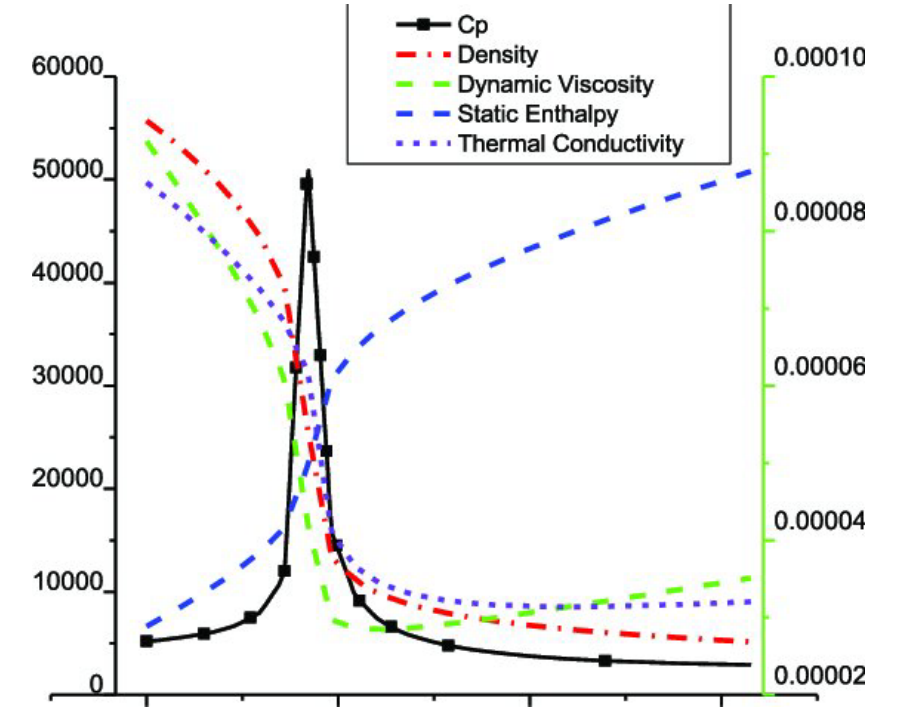
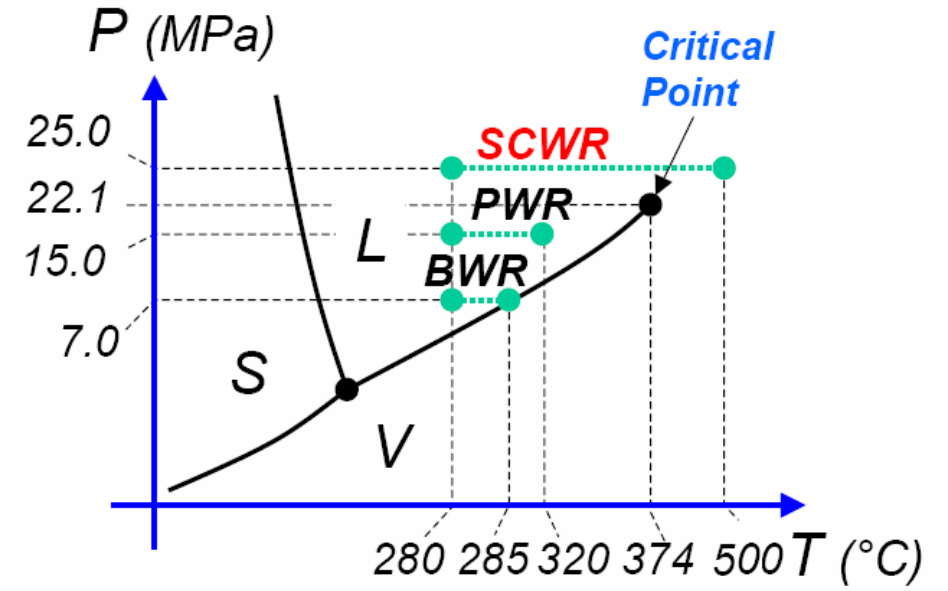

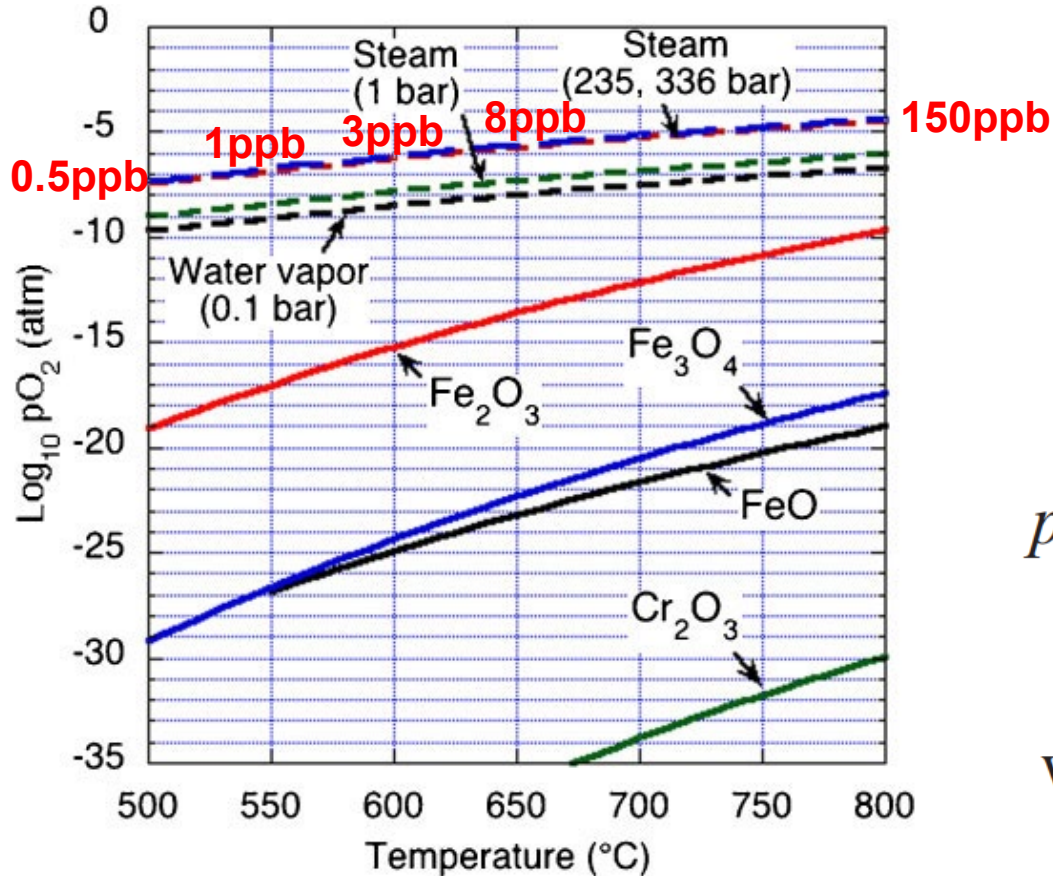

Effective oxygen partial pressures in steam under three pressure conditions, and the stability of the oxides of interest as a function of oxygen partial pressures



$$k_7 = p\text{O}_2^{0.5} p\text{H}_2 / p\text{H}_2\text{O}$$

$$\log k_7 = -\Delta G_7^0 / 2 \cdot 303RT$$

$$\Delta G_7^0 = -230\,000 - 8.14T \ln(T) + 9.25T$$

$$p\text{O}_2 = [x / (2 + x)]P \quad p\text{H}_2 = [2x / (2 + x)]P$$

$$p\text{H}_2\text{O} = [2(1 - x) / (2 + x)]P$$

where  $x \ll 1$ ,  $k_7^2 = P x^3 / 2$

$$p\text{O}_2 = (k_7 / 2)^{2/3} P^{2/3}$$



# Corrosion Phenomena in SCWR Core

Coolant experience subcritical, critical and supercritical state, which correspond to different corrosion mechanism.

## Supercritical region

Oxidization, evaporation of corrosion products, creep, IASCC

## Critical Region

Precipitation of oxides

## Subcritical Region

Electrochemical dissolution, metallic ions dissolved in coolant, SCC due to electrochemical factors

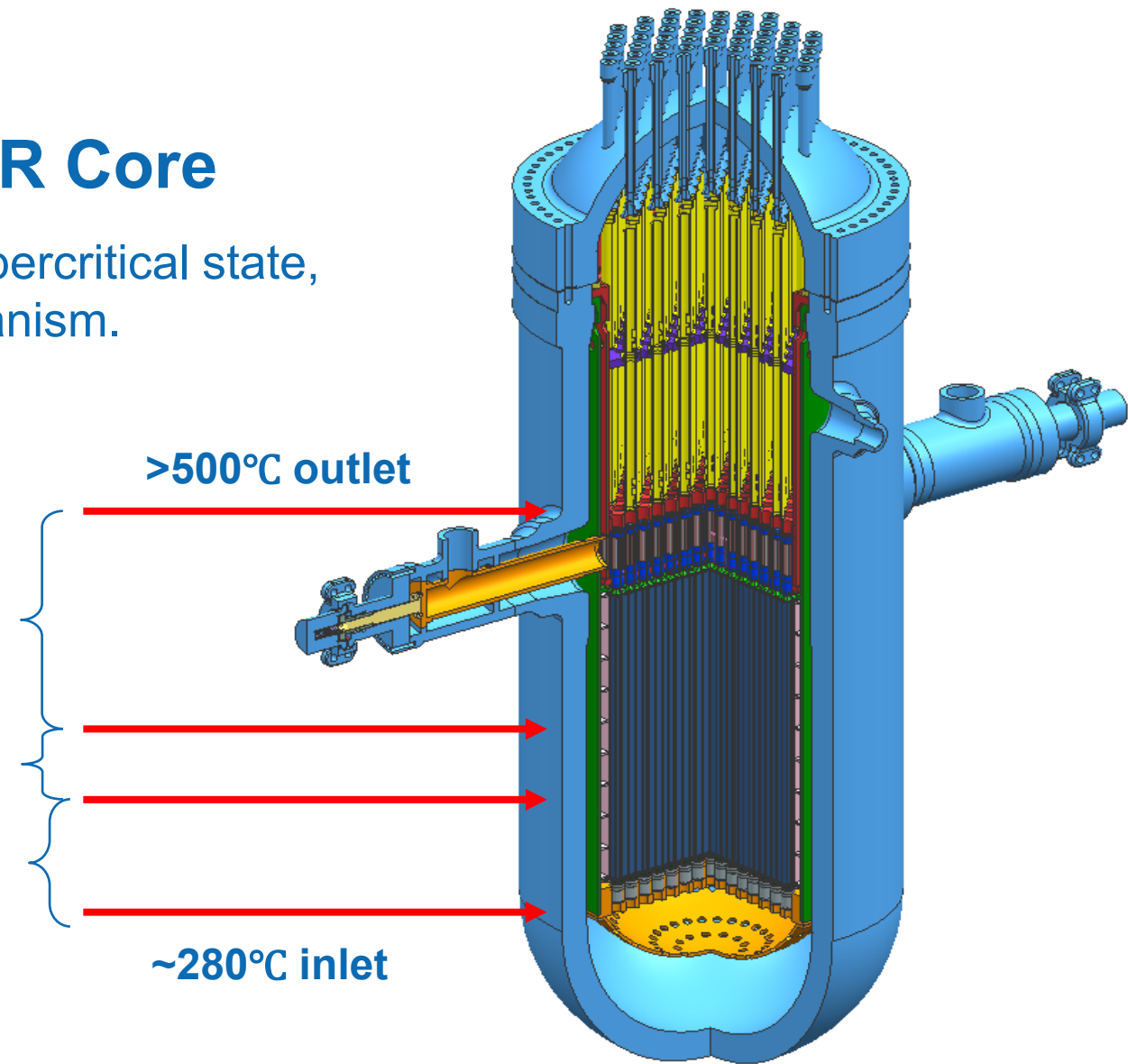

CSR1000 designed by NPIC, China

# Formation and stability of protective oxide film

## Subcritical water

precipitation

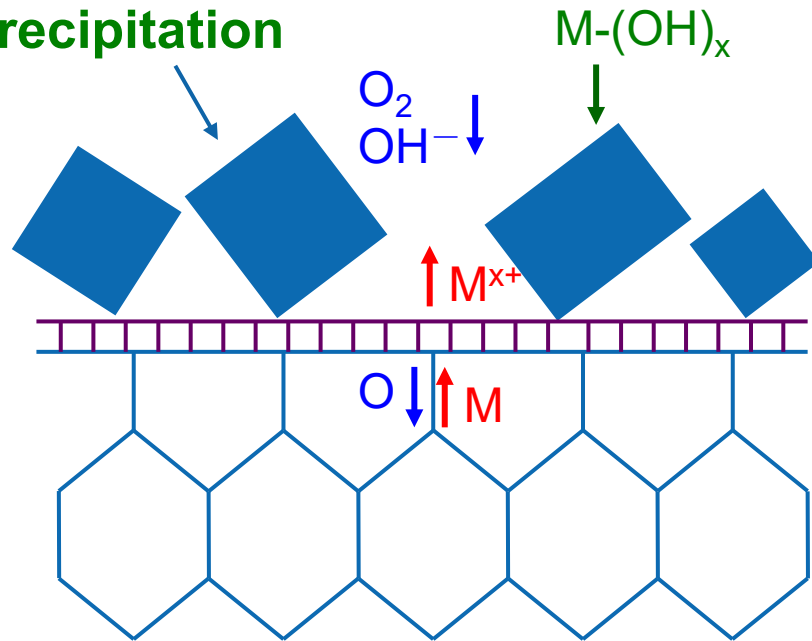

Matrix Metal

Protective film  
(grow)

M- Fe, Cr, Ni, Mn, Mo, Al, etc

## Supercritical water/vapor

$CrO_2(OH)_2$   
(gas)

Diffusion  
Porous film ( $Fe_3O_4$ )  
with cracks

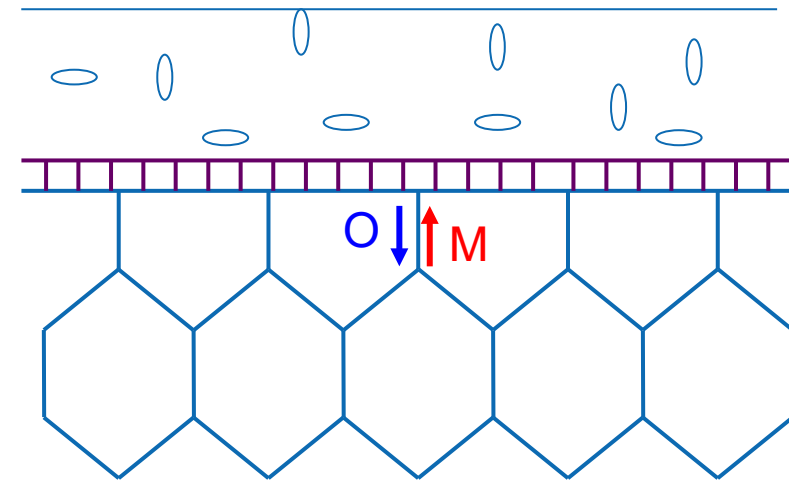

Matrix Metal

# Protective oxides on metallic materials of interest

## Protective oxide films

- Steels and Ni alloy:  $\text{Cr}_2\text{O}_3$ ,  $(\text{Cr},\text{M})_3\text{O}_4$ ,  $\text{Fe}_3\text{O}_4$ ,  $(\text{Cr},\text{M})_2\text{O}_3$
- Al, Al alloys: corundum type  $\alpha - \text{Al}_2\text{O}_3$
- Zr and Zr alloys: un-stoichiometric  $\text{ZrO}_{2-x}$

## Vaporization in steam

- $1/2 \text{Cr}_2\text{O}_3(\text{S}) + \text{H}_2\text{O}(\text{g}) + 3/4\text{O}_2(\text{g}) = \text{CrO}_2(\text{OH})_2(\text{g})$  ;
- $\text{Cr}_2\text{O}_3(\text{S}) + 5\text{H}_2\text{O}(\text{L}) = 2\text{CrO}_4^{2-} + 10\text{H}^+ + 8\text{e}$ .
- $1/2 \text{Al}_2\text{O}_3(\text{S}) + 3/2\text{H}_2\text{O}(\text{g}) = \text{Al}(\text{OH})_3(\text{g})$  ;
- $\text{SiO}_2 + 2\text{H}_2\text{O}(\text{g}) = \text{Si}(\text{OH})_4(\text{g})$  ;
- $\text{SiO}_2 + \text{H}_2\text{O}(\text{g}) = \text{SiO}(\text{OH})_2(\text{g})$  ;
- $\text{SiO}_2 + 1/2\text{H}_2\text{O}(\text{g}) = 1/4\text{O}_2(\text{g}) + \text{SiO}(\text{OH})_2(\text{g})$ .

$$J_{\text{Cr}} = K_m (v/l)^{1/2} P \quad k_{18} = p\text{CrO}_2(\text{OH})_2 / (p\text{O}_2^{3/4} p\text{H}_2\text{O})$$

$$\Delta G_{18}^0 = 53\,500 + 45 \cdot 5T \quad p\text{CrO}_2(\text{OH})_2 = k_{18} (k_7/2)^{1/2} P^{3/2}$$

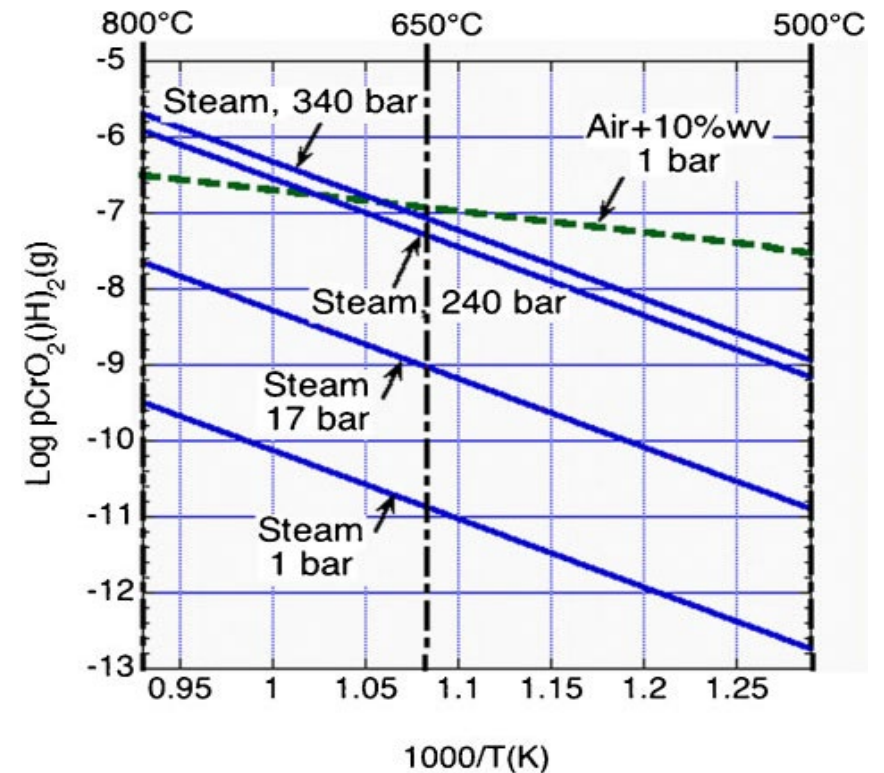

# Cr evaporation/depletion kinetics

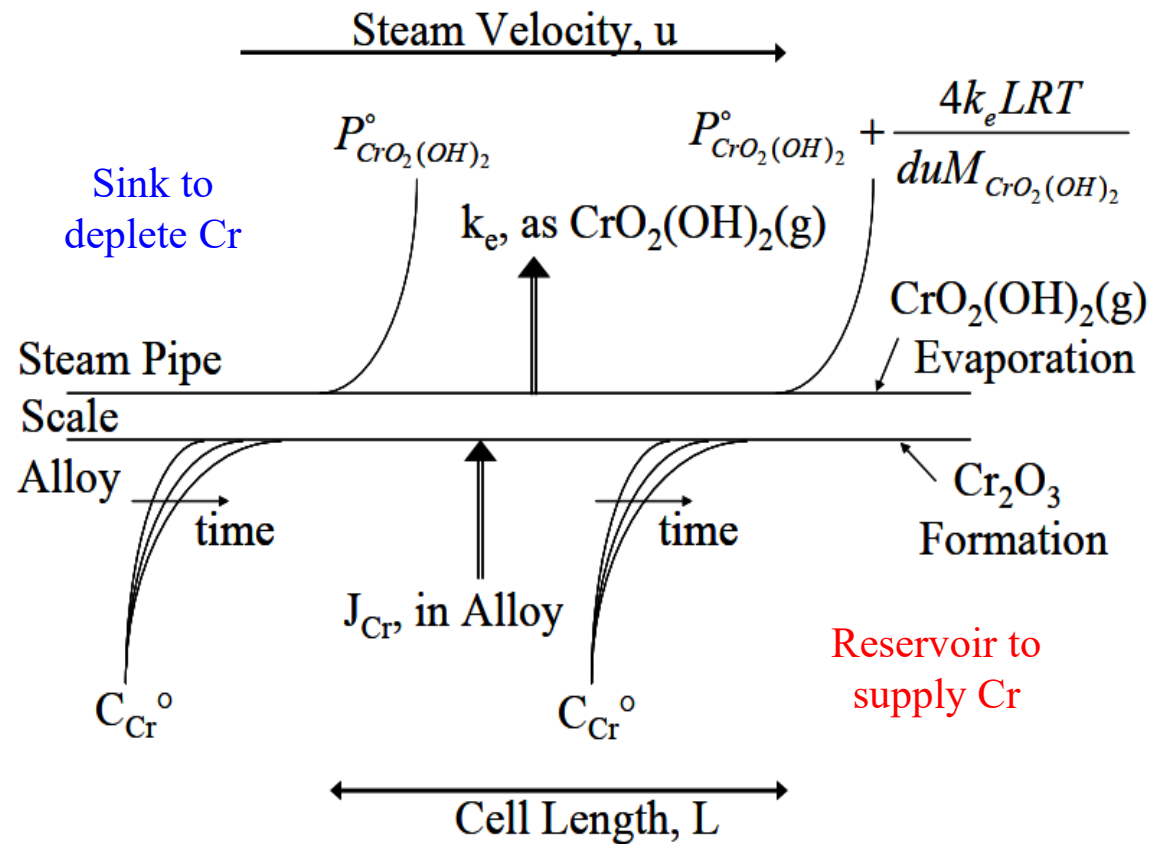

$\frac{dx}{dt} = \frac{k_p}{x} - k_e$     The Limiting scale thickness     $x_L = \frac{k_p}{k_e}$

In laminar flow

$$k_e \left( \frac{kg}{m^2 \cdot s} \right) = 0.664 Re_L^{0.5} Sc^{0.343} \frac{D_{AB} M_{CrO_2(OH)_2}}{LRT} P_{CrO_2(OH)_2}$$

In turbulence flow

$$k_e \left( \frac{kg}{m^2 \cdot s} \right) = 0.0592 Re_L^{0.8} Sc^{0.333} \frac{D_{AB} M_{CrO_2(OH)_2}}{LRT} P_{CrO_2(OH)_2}$$

Cr concentration at surface     $C_{Cr}(0,t) = C_{Cr}^\circ - \frac{2k_e}{M_{CrO_2(OH)_2}} \sqrt{\frac{t}{\pi D_{Cr}}}$

Time to Cr% ~0 at surface     $t^* = \frac{\pi D_{Cr}}{4} \left( \frac{M_{CrO_2(OH)_2} C_{Cr}^\circ}{k_e} \right)^2$

Coefficient of Cr diffusion     $D_{Cr} \cong D_{Cr}^L + \frac{2\delta}{\lambda} D_{Cr}^{gb}$

Surface shot pinning    Dislocation density    Grain size ~nano GB



# Short listed candidate materials for SCWR

## Fuel cladding materials (<0.5 mm thick)

- 310s : borrowed from fossil fueled plants, corrosion resistance
- Alloy 800/800H, 825, 625: promising
- Oxide dispersion strengthened (ODS) steels
- Alumina forming austenitic (AFA) stainless steels

## Reactor internals

- Austenitic stainless steels, such as 310S
- Super stainless steels

## Reactor pressure vessels and primary piping

- P22/SA508cl.4 clad with SS, super stainless steels 304, 347
- P91/92, P122, alloy 800H

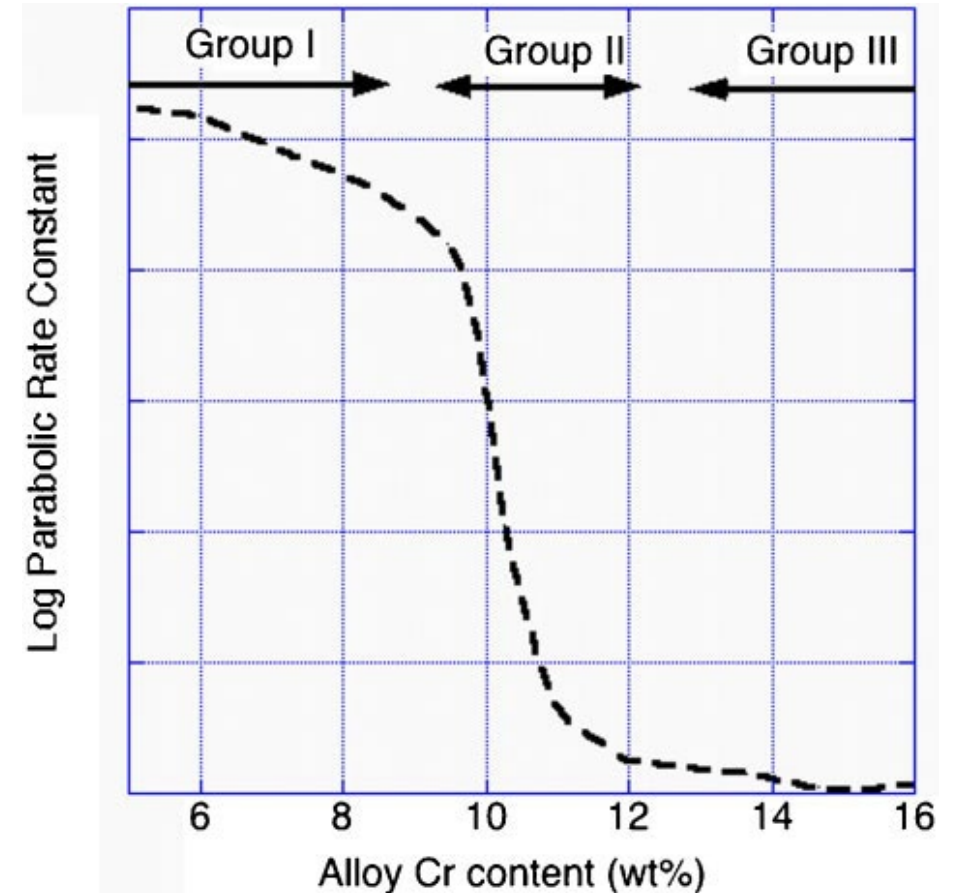

# Concerns of SCWR materials

## General and flow accelerated corrosion:

- Oxidation
- Dissolution + vaporization
- Exfoliation (oxide particles)

## Creep and stress corrosion cracking

- Corrosion-Sensitization/Grain boundary oxidation
- Creep cracking
- Cyclic rupture of oxide film and repassivation at crack tip
- Blunting of fatigue crack tip

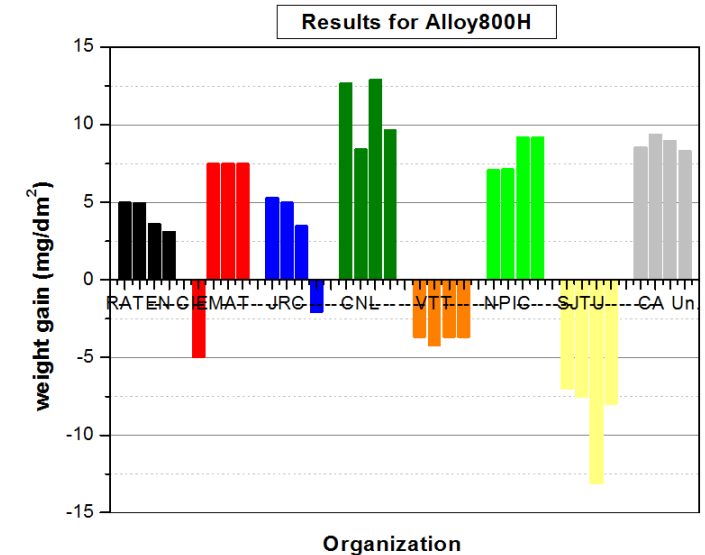
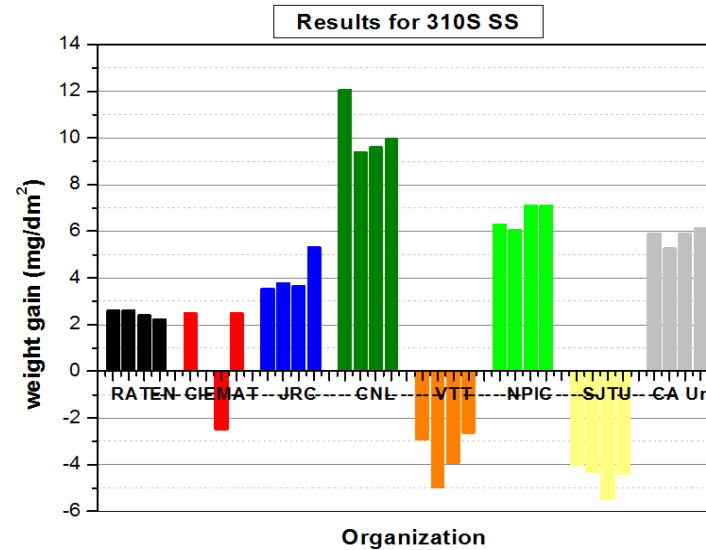
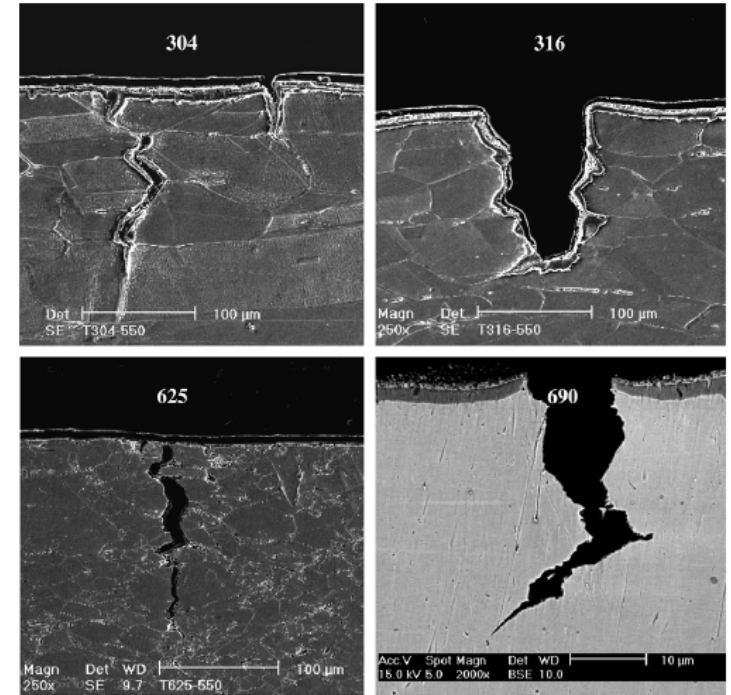

# Concerns of SCWR materials

## SCWR cladding materials

- Excellent corrosion performances
- Very low environmental cracking susceptibility (SCC + creep)

## Commercial and novel materials

- Alloy 800H, 310S austenitic stainless steel
- AFA steels based on high Cr alloy
- ODS steel or ODS+AFA alloy

## Cladding tube manufacturing

- Deformation, heat treatment, surface ...

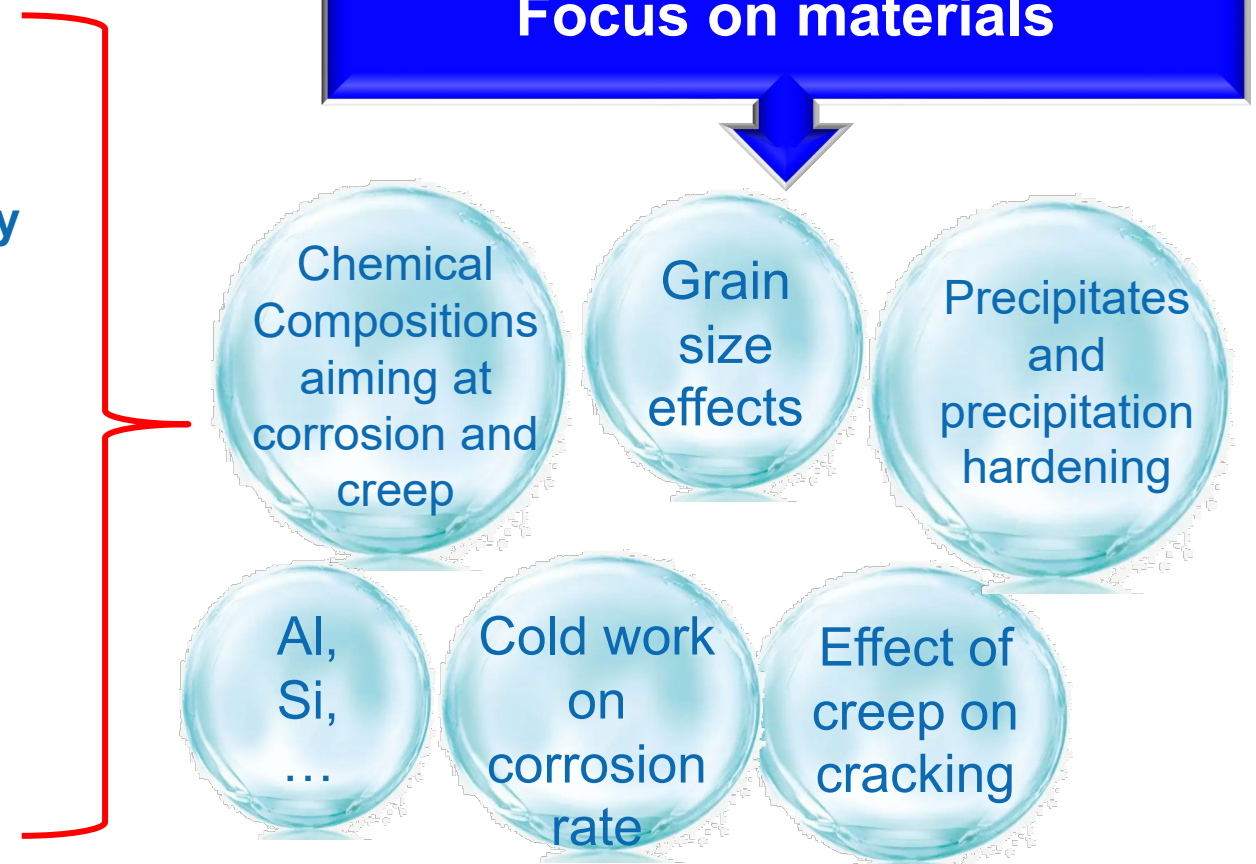

**Radiation hardening and embrittlement is not the major work at present**

# Commercial alloys

# Ferritic/martensitic (F/M) steels

## 3-layered oxide film:

- outer layer:  $\text{Fe}_3\text{O}_4/\text{Fe}_2\text{O}_3$
- middle layer:  $\text{FeCr}_2\text{O}_4$ ,  $(\text{FeCr})_3\text{O}_4$
- internal layer: oxygen penetration

## High corrosion rate:

- weak-protective oxide film
- Spallation due to mismatch of thermal expansion within temperature range 550~600°C

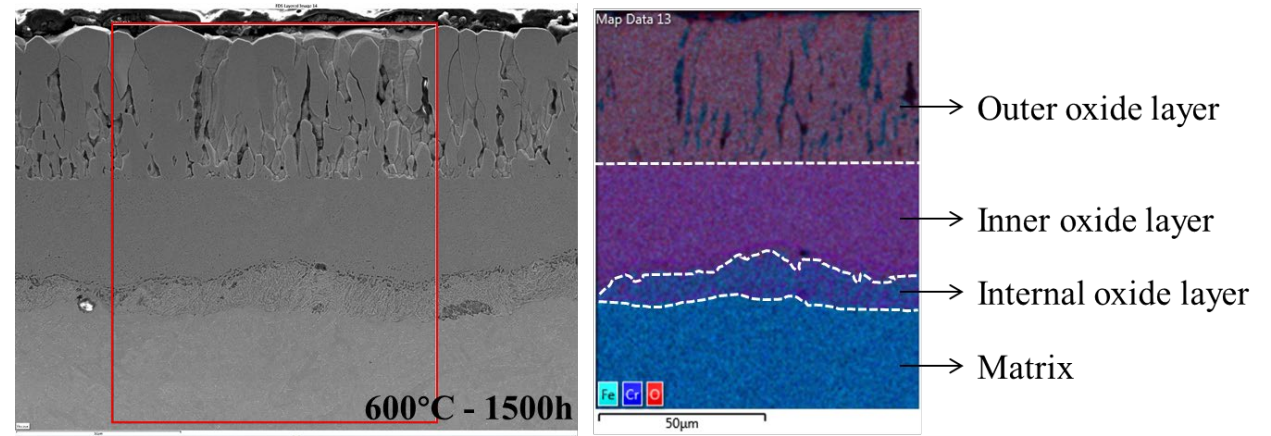
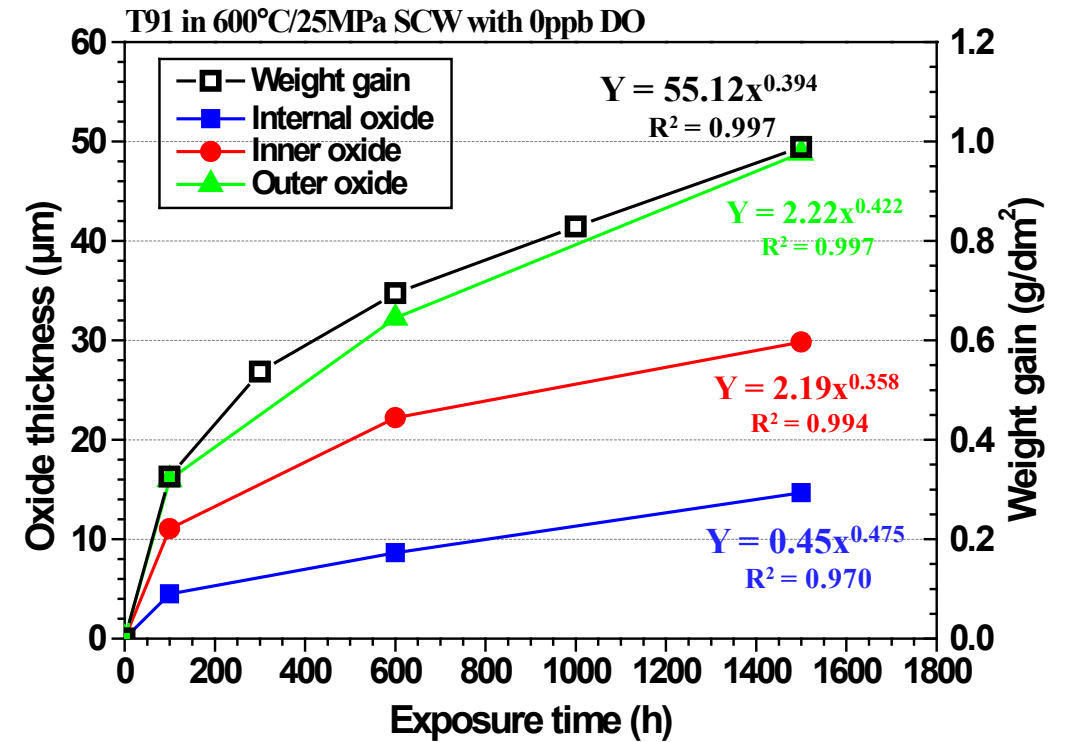



# Austenitic steels: 304/316/310S

## 2-layered oxide film:

- outer layer:  $\text{Fe}_3\text{O}_4/\text{Fe}_2\text{O}_3$
- Inner layer:  $\text{FeCr}_2\text{O}_4$ ,  $(\text{FeCr})_3\text{O}_4$

## Medium corrosion rate:

- suffer nodule corrosion

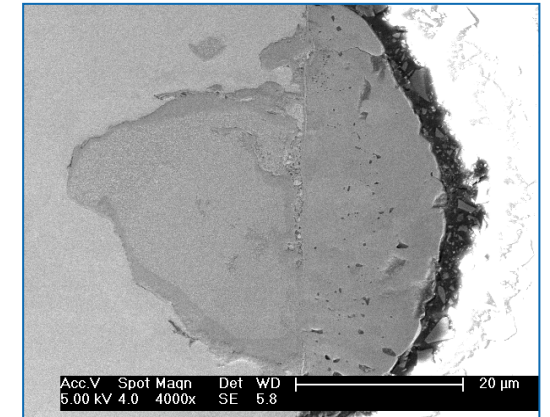
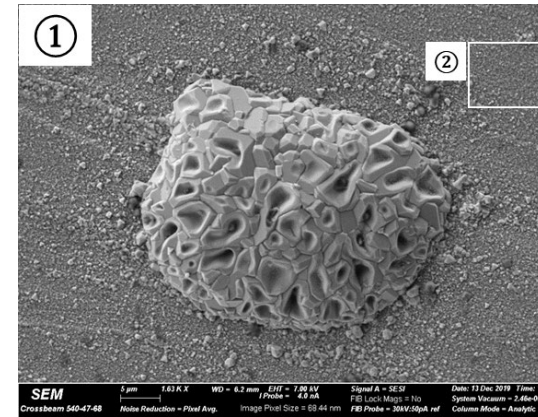

304NG SS, 300 h in 600°C SCW

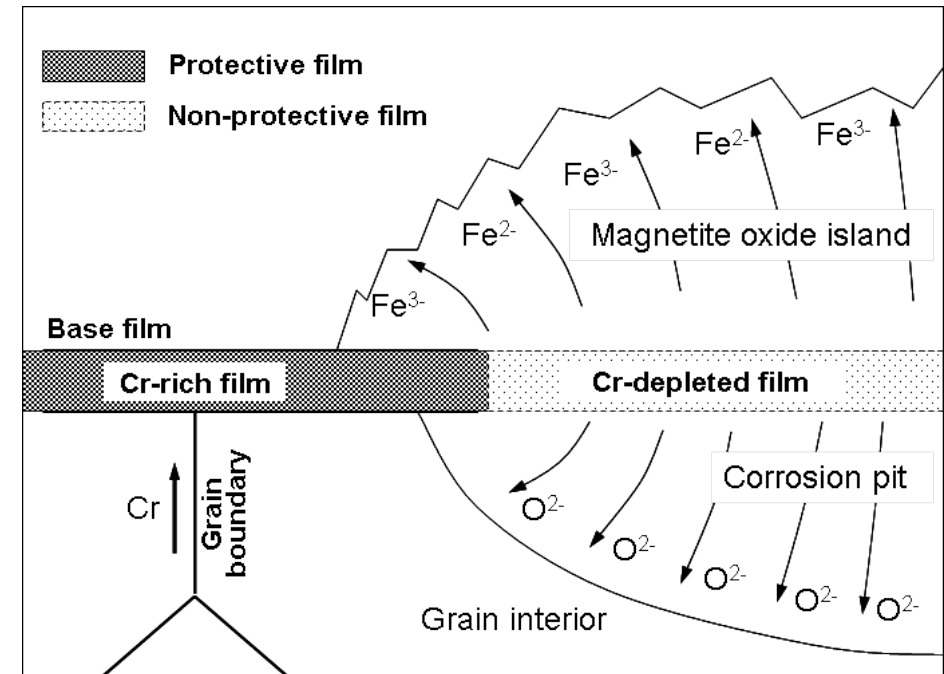
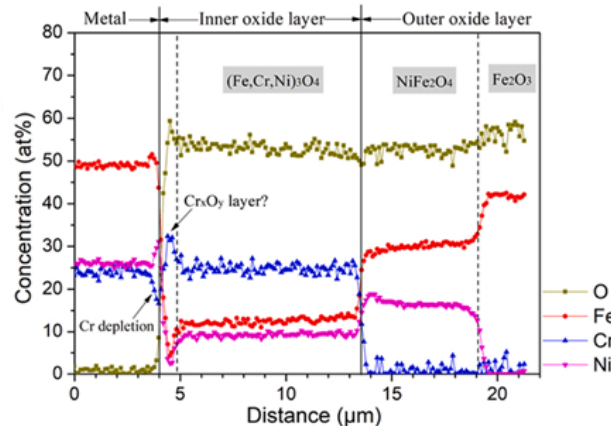
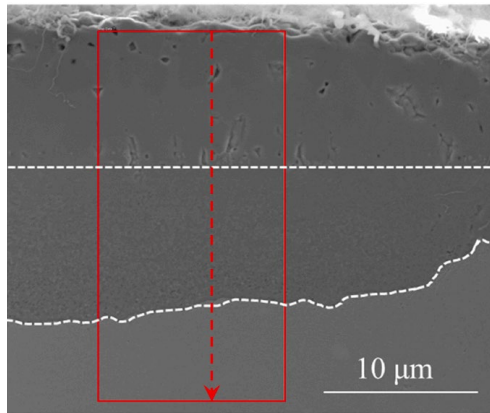

# Austenitic steels: 304/316/310S

## High cracking susceptibility:

- high intergranular cracking rates in SCW environment, especially in oxygenated SCW.

## Sensitization:

- Above 400°C, austenitic steels suffer sensitization, which increases the cracking susceptibility of grain boundaries.

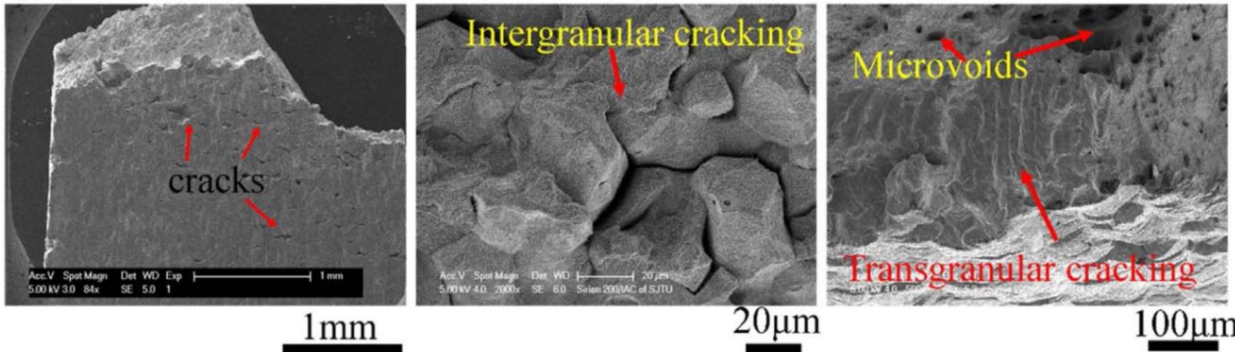
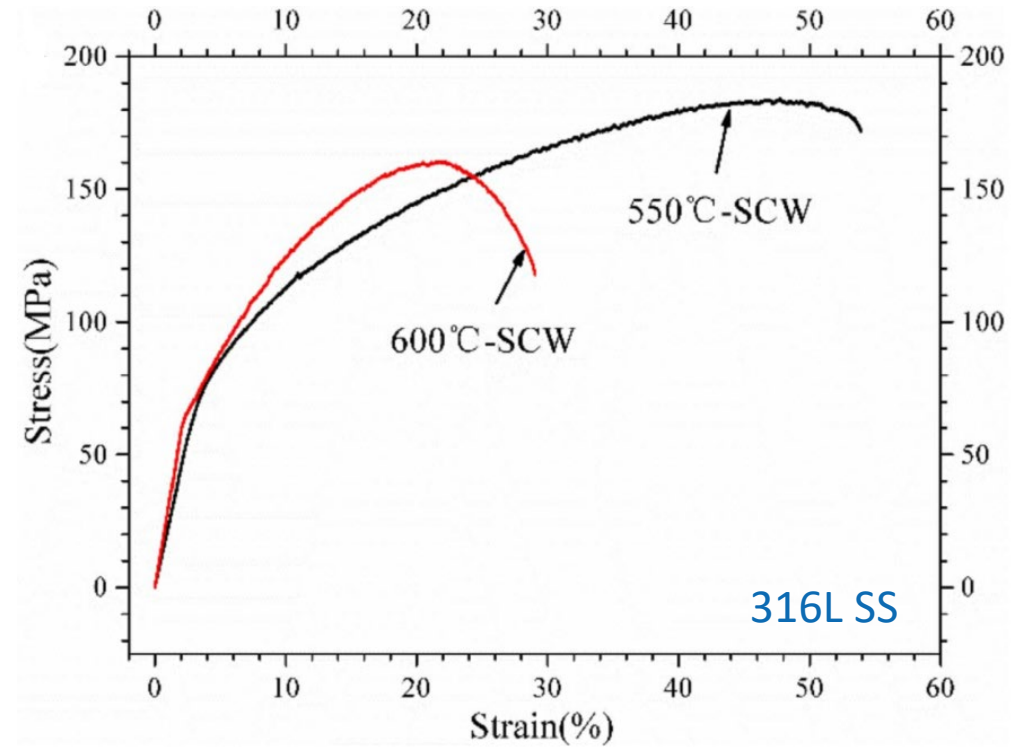

316L SS after SSRT in 600°C SCW

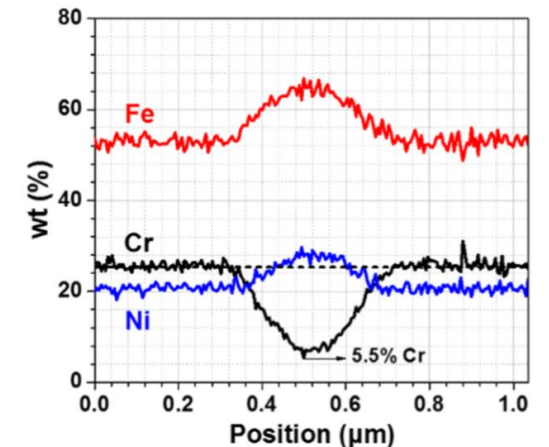
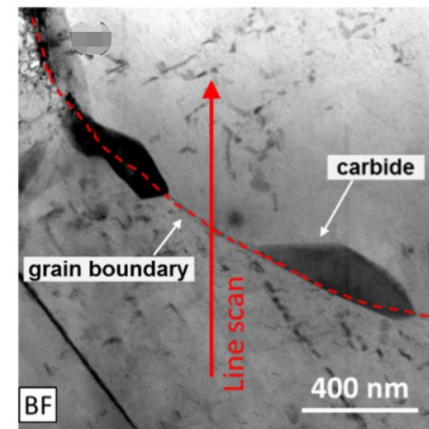



# Austenitic steels: 310S SS

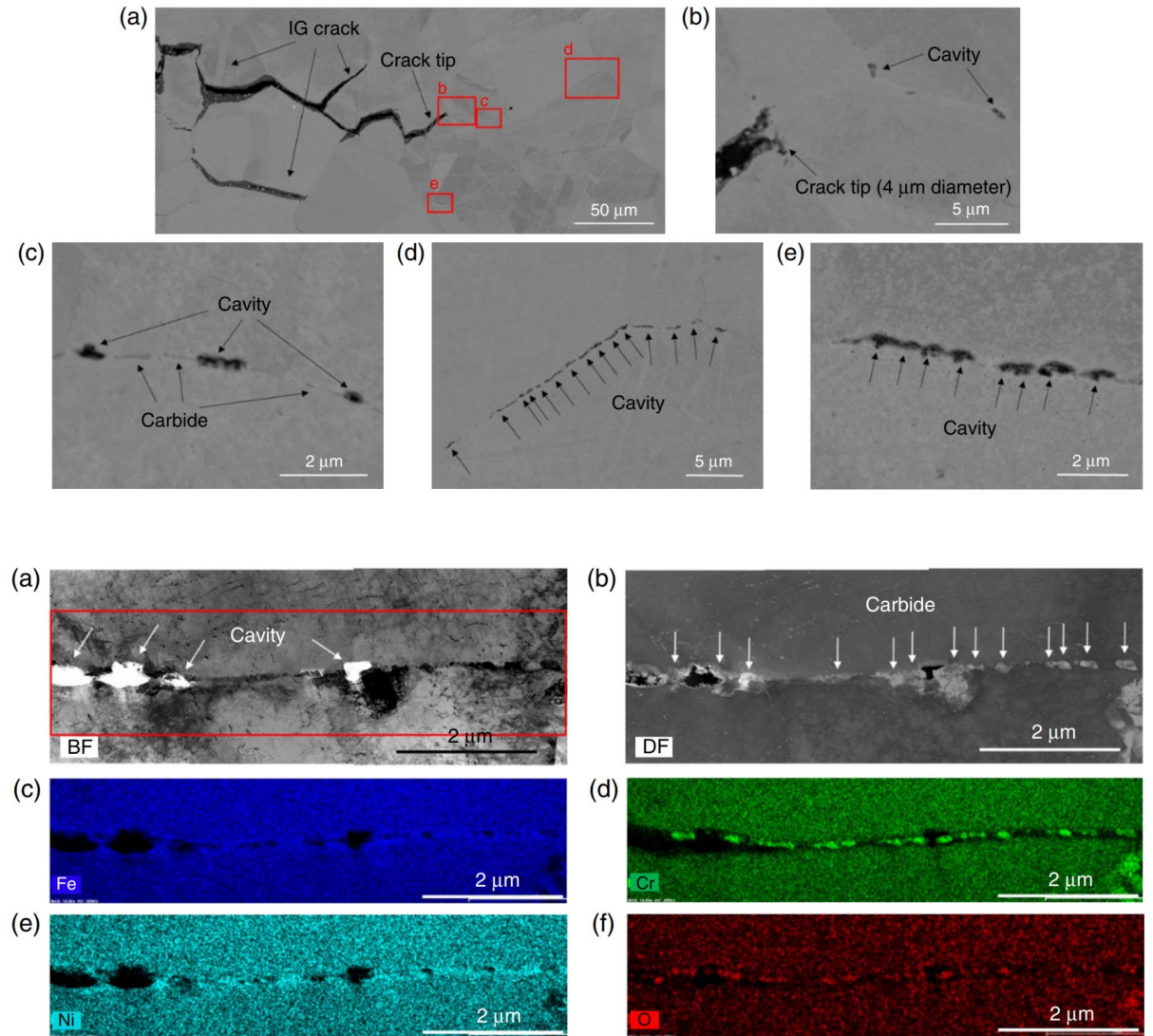
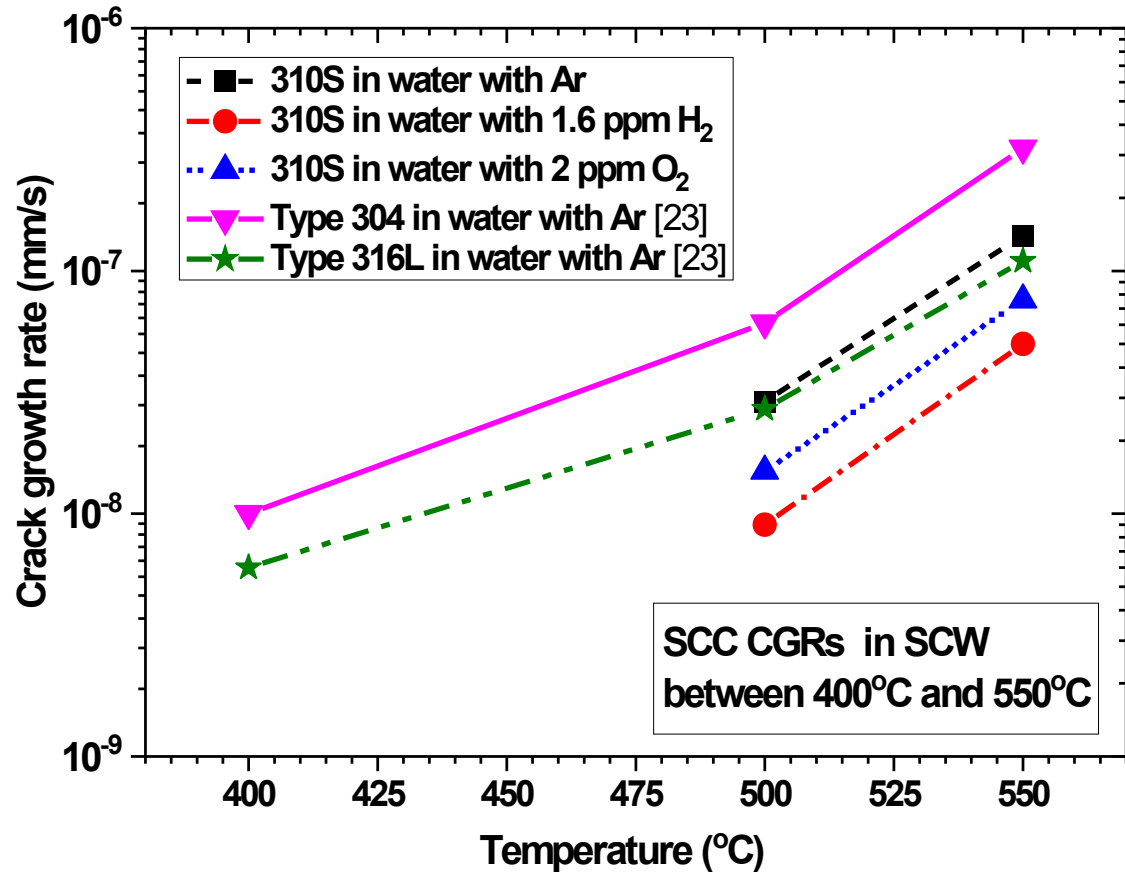



# Austenitic steels: 800H

## General corrosion vs cold work

- Corrosion rate and the affecting factors
- Surface effect, fine grain surface layer
- Diffusion enhancing factors: dislocation, GB, T...

800H, 1000 h in deaerated 600°C SCW, 0% vs. 80% cold-rolled

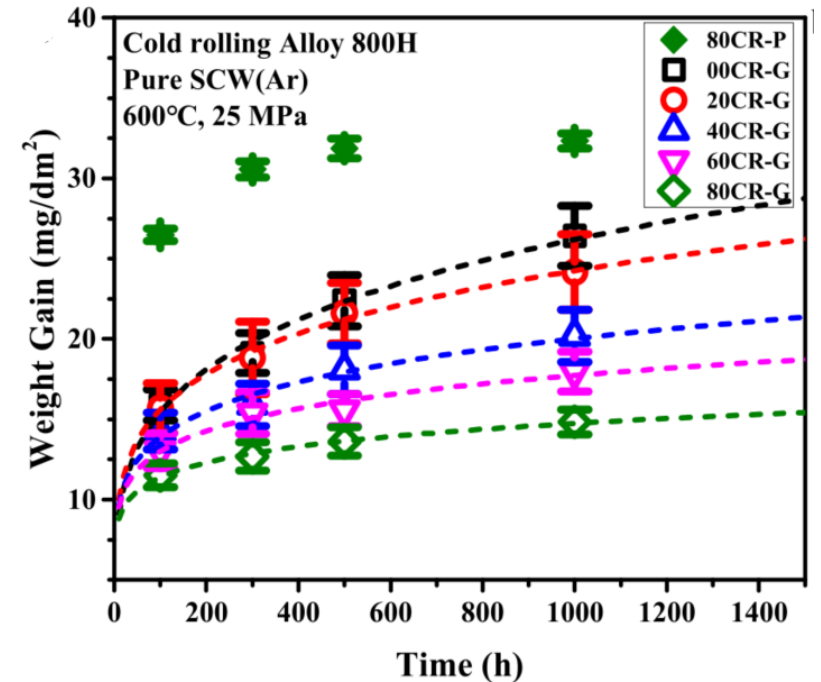
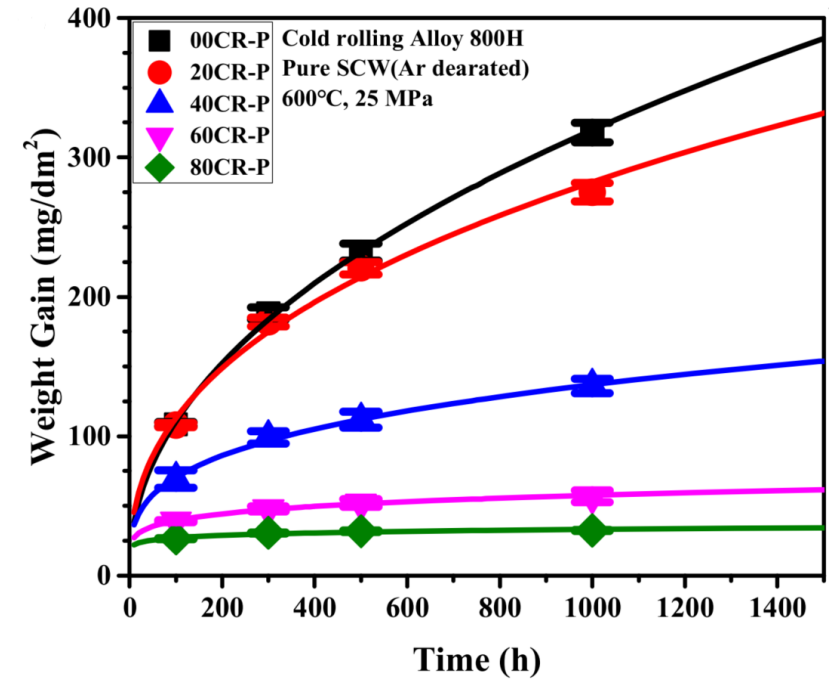
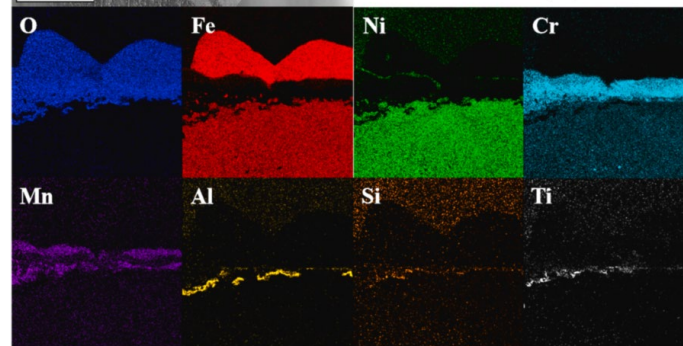
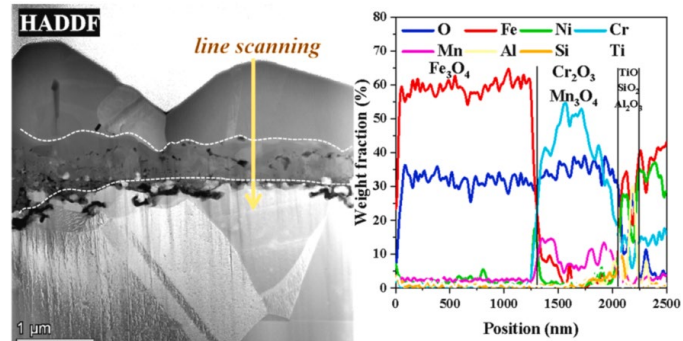
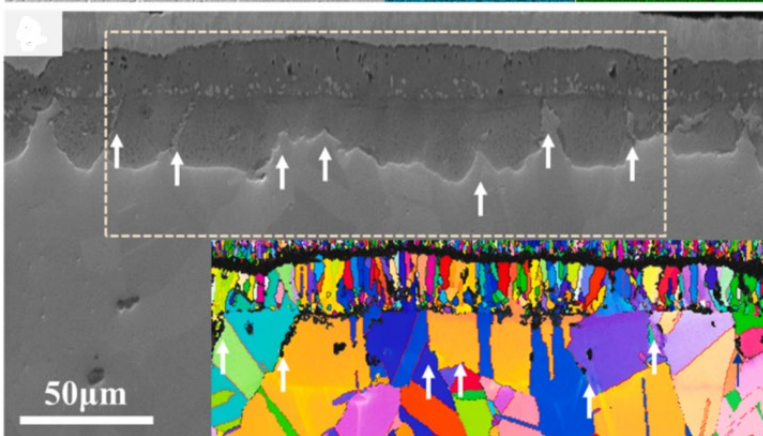
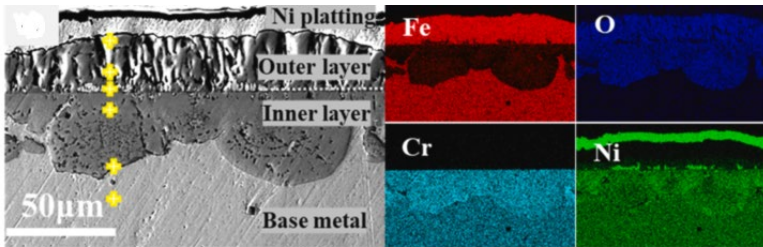



# Austenitic steels: 800H, polishing vs. ground finish

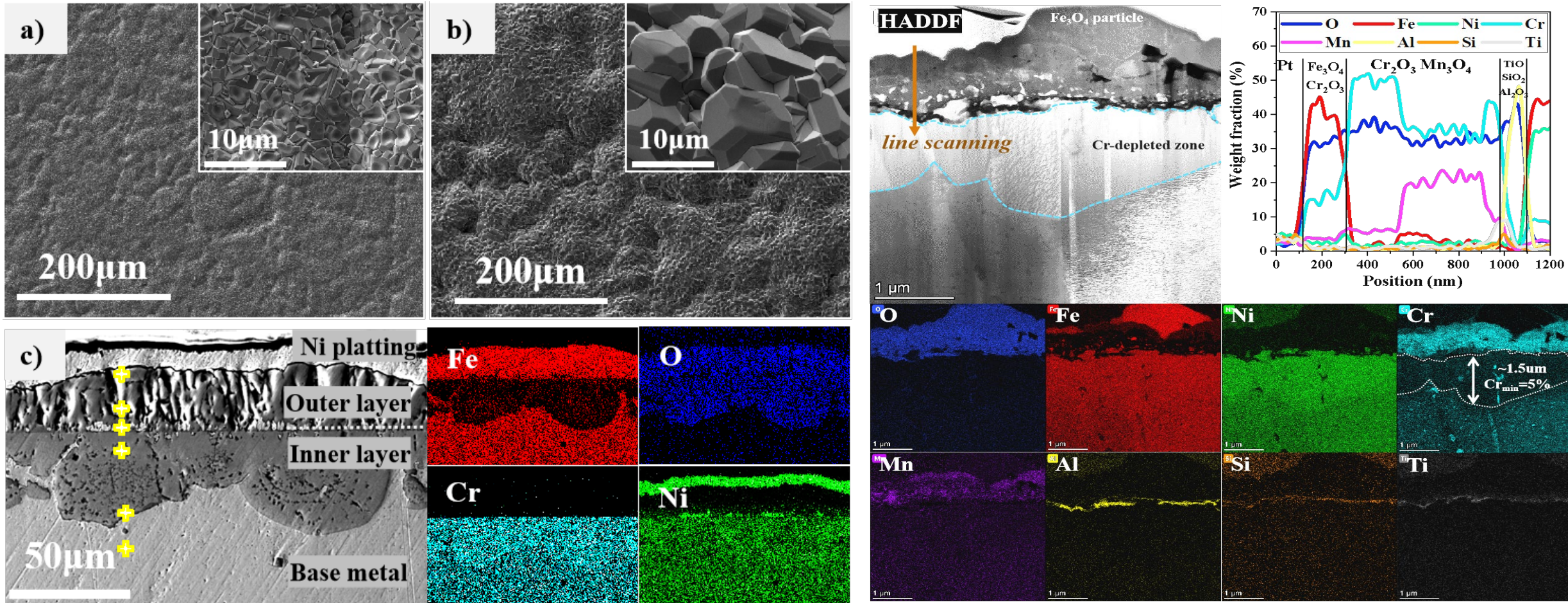



# Austenitic steels: 800H

## General corrosion vs grain size

- Smaller grain size → lower oxidation rate
- **Deformation** (cold rolling or surface grinding) and **grain refinement** promote the outward diffusion of Cr to facilitate the formation of  $Cr_2O_3$

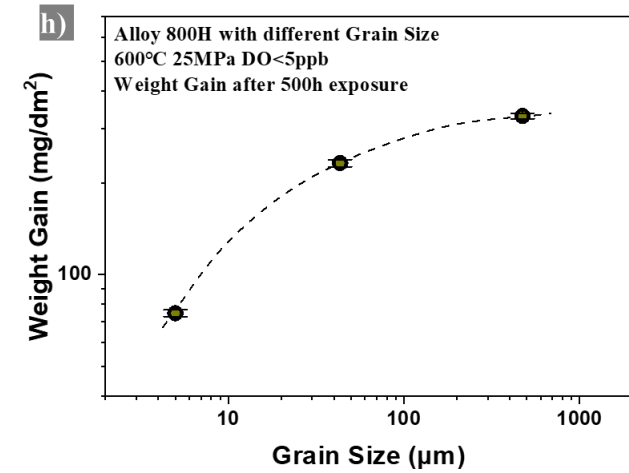
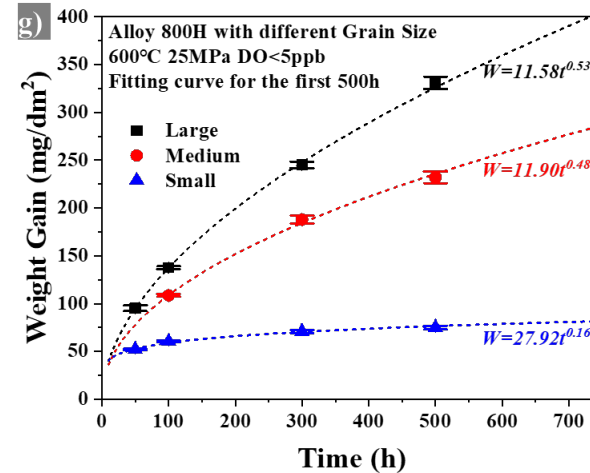
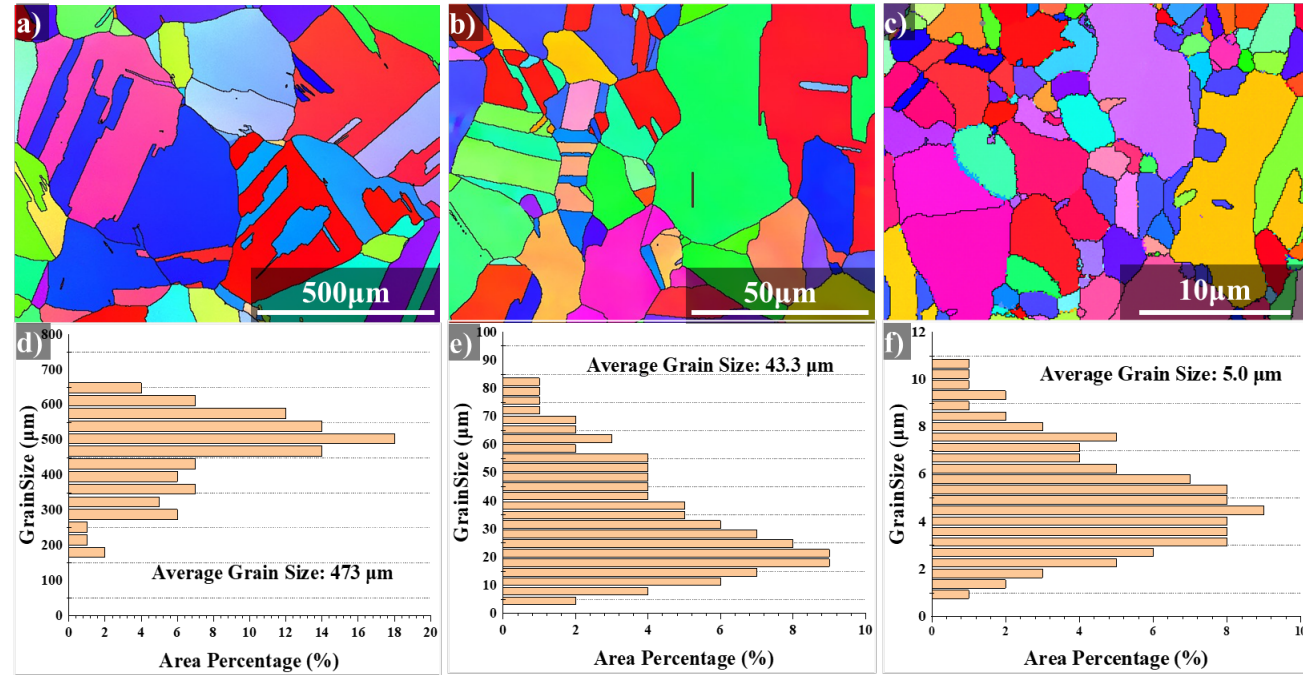
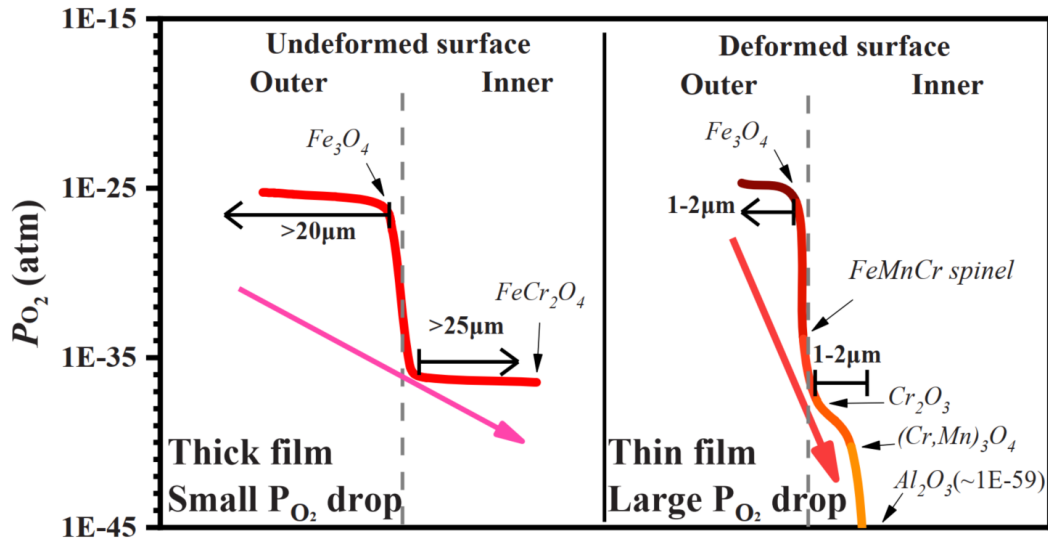

# Austenitic steels: 800H

## High crack growth rate after cold deformation:

- 100% intergranular crack
- High percentage contribution by creep
- In-situ sensitization, which weakens the grain boundary

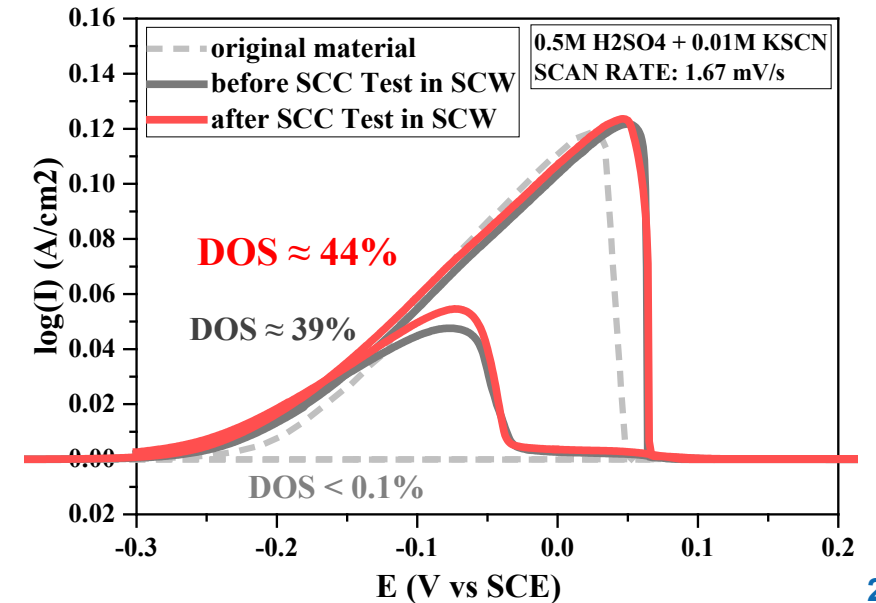
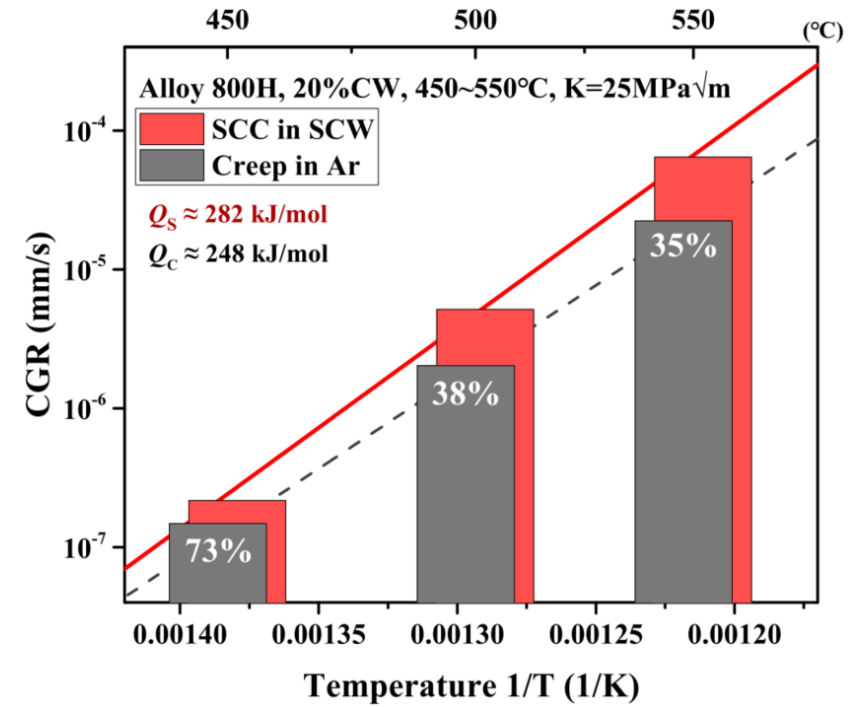
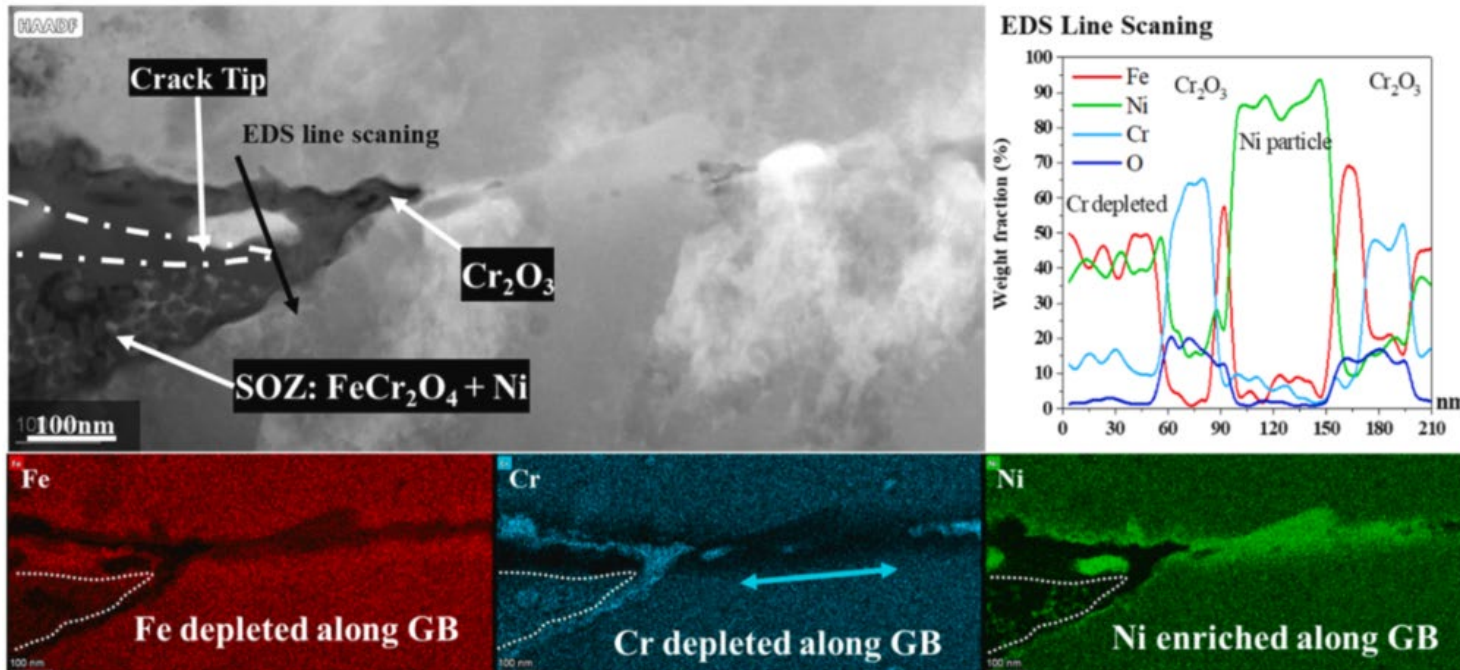

# Nickel-based alloys: Alloy 690

## Low oxidation rate:

- 2-layer oxide film
- High Cr content enables the formation of protective  $\text{Cr}_2\text{O}_3$  scale.

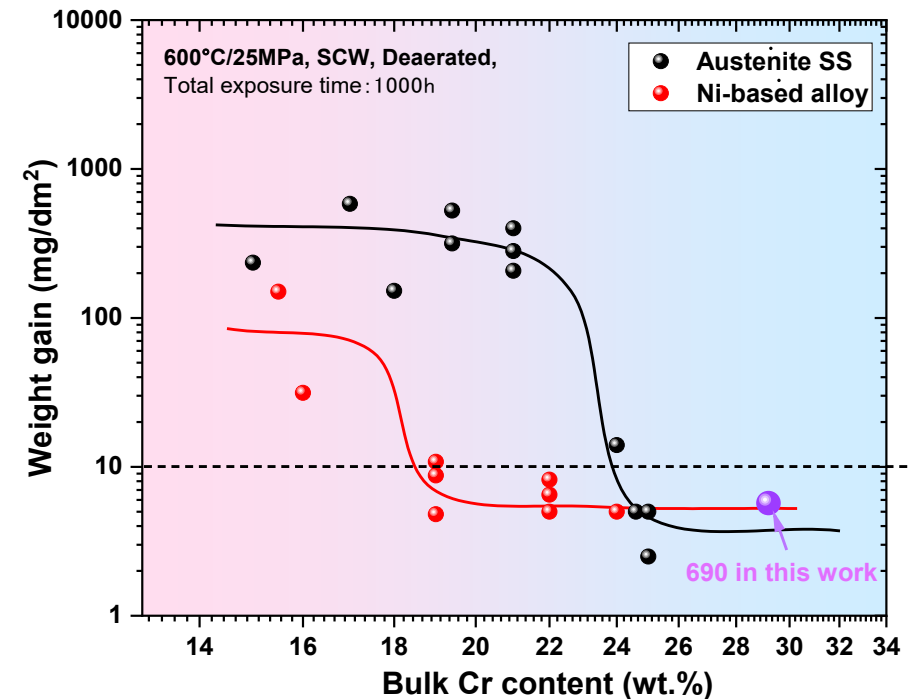
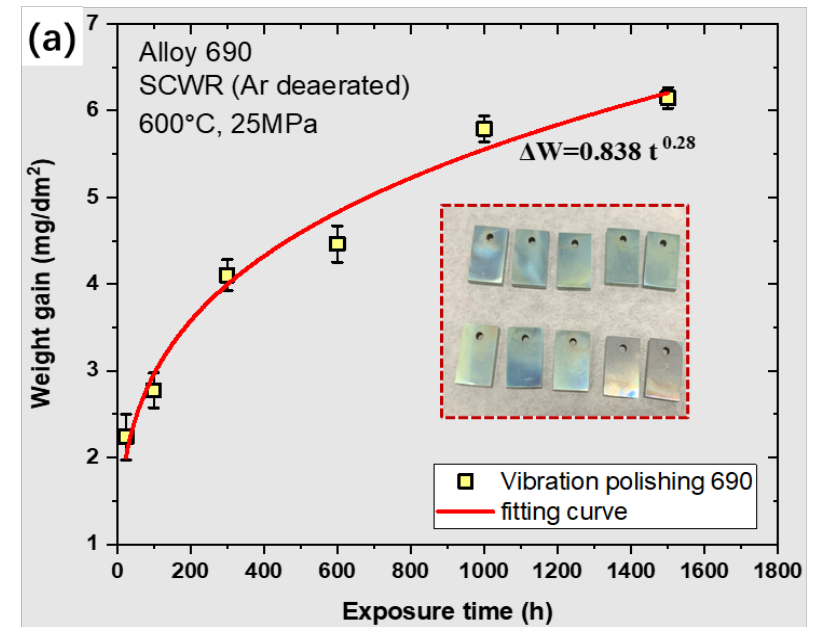
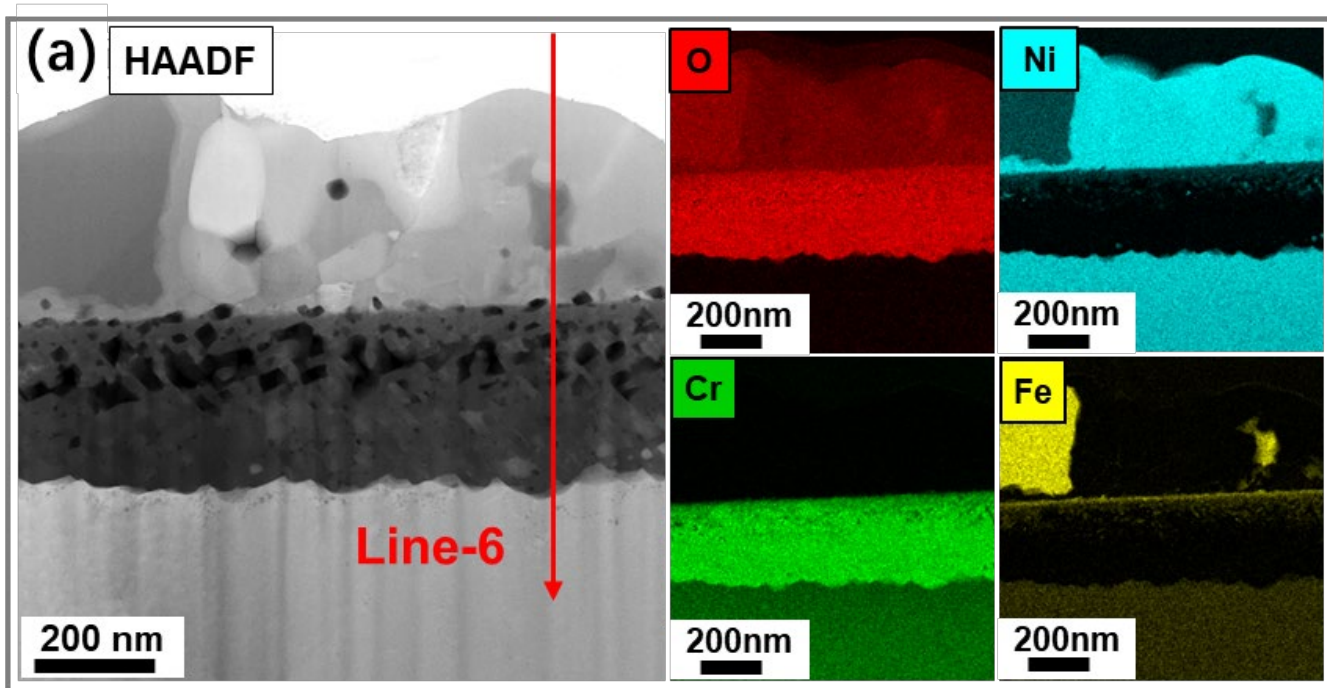



# Nickel-based alloys: Alloy 690

## Medium cracking rate:

- Creep and in-situ sensitization contributes.
- Cold work and T increase the cracking rates.

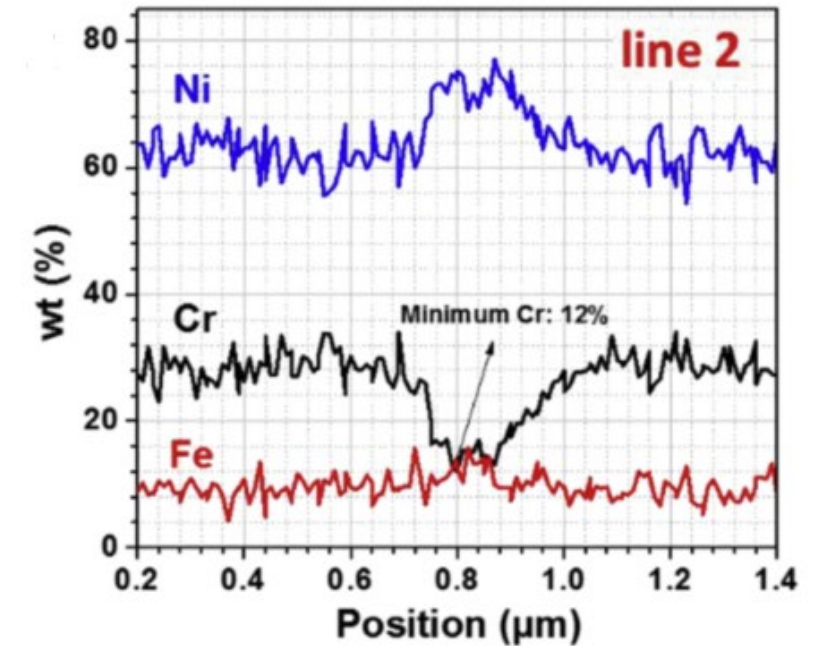
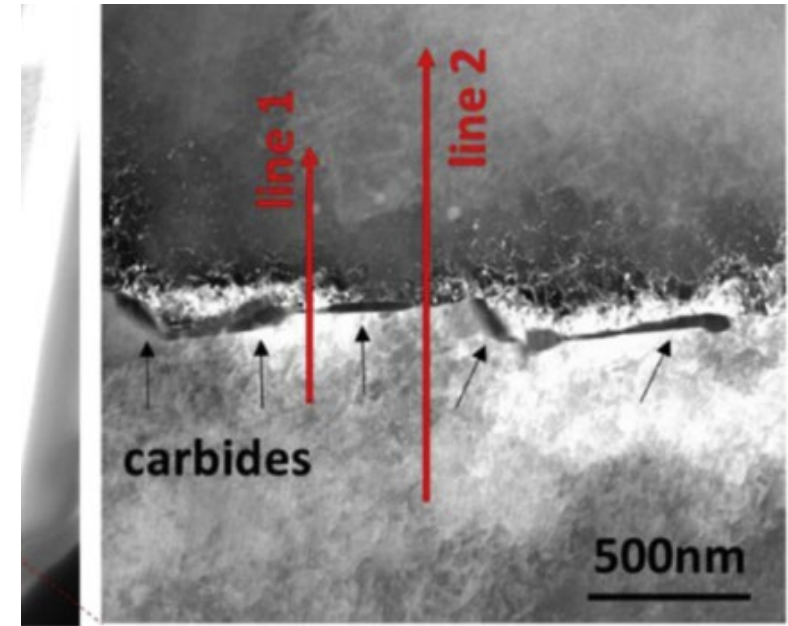
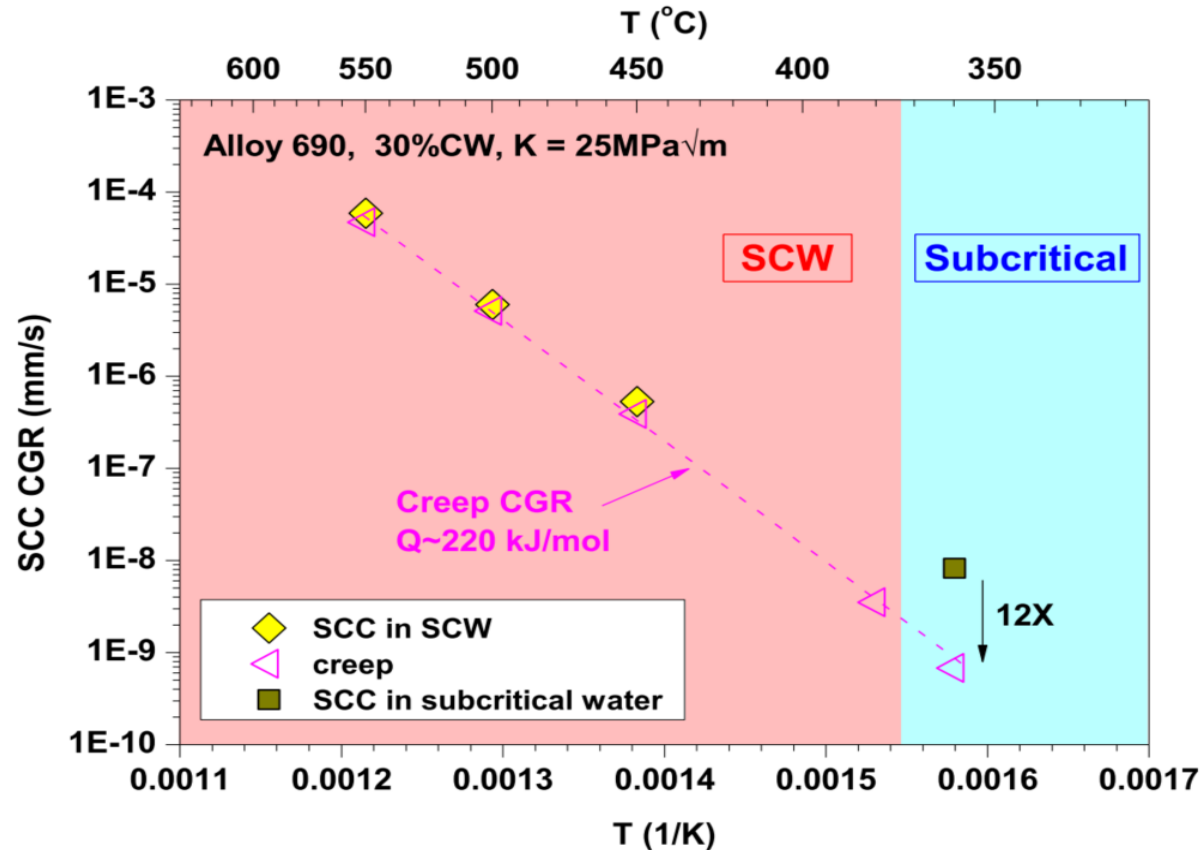

# Irradiation effects

# Radiation induced segregation at 500°C up to 7dpa

## Cr-depletion and Ni-enrichment at grain boundaries

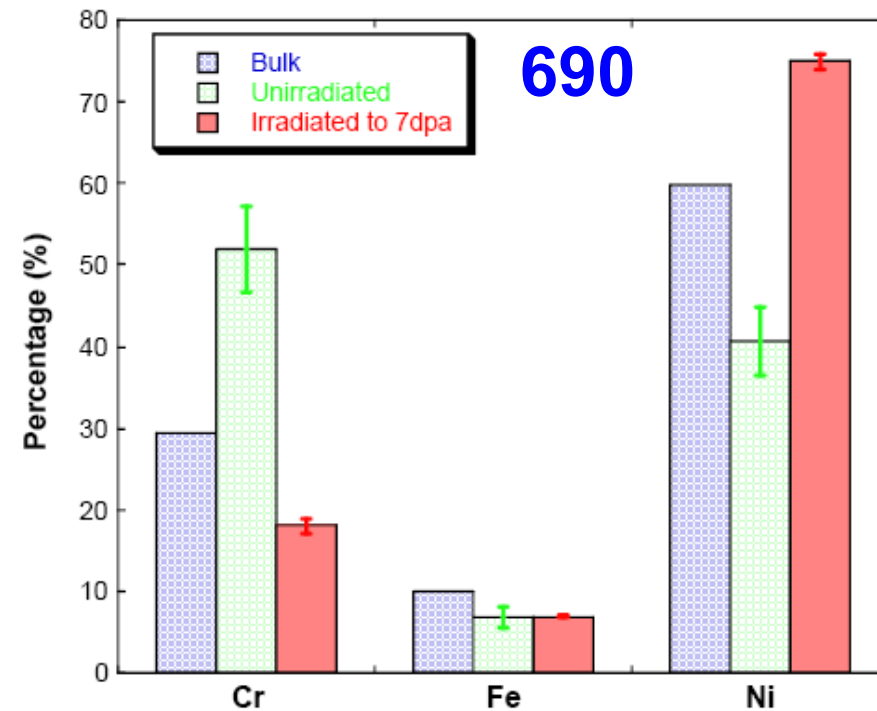
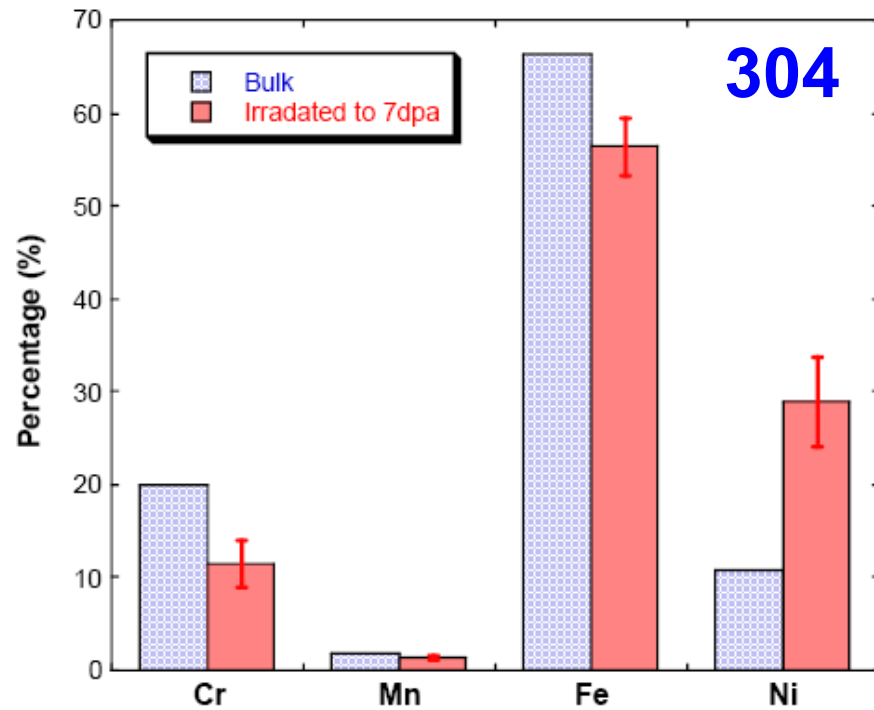



# Increased SCC susceptibility after irradiation

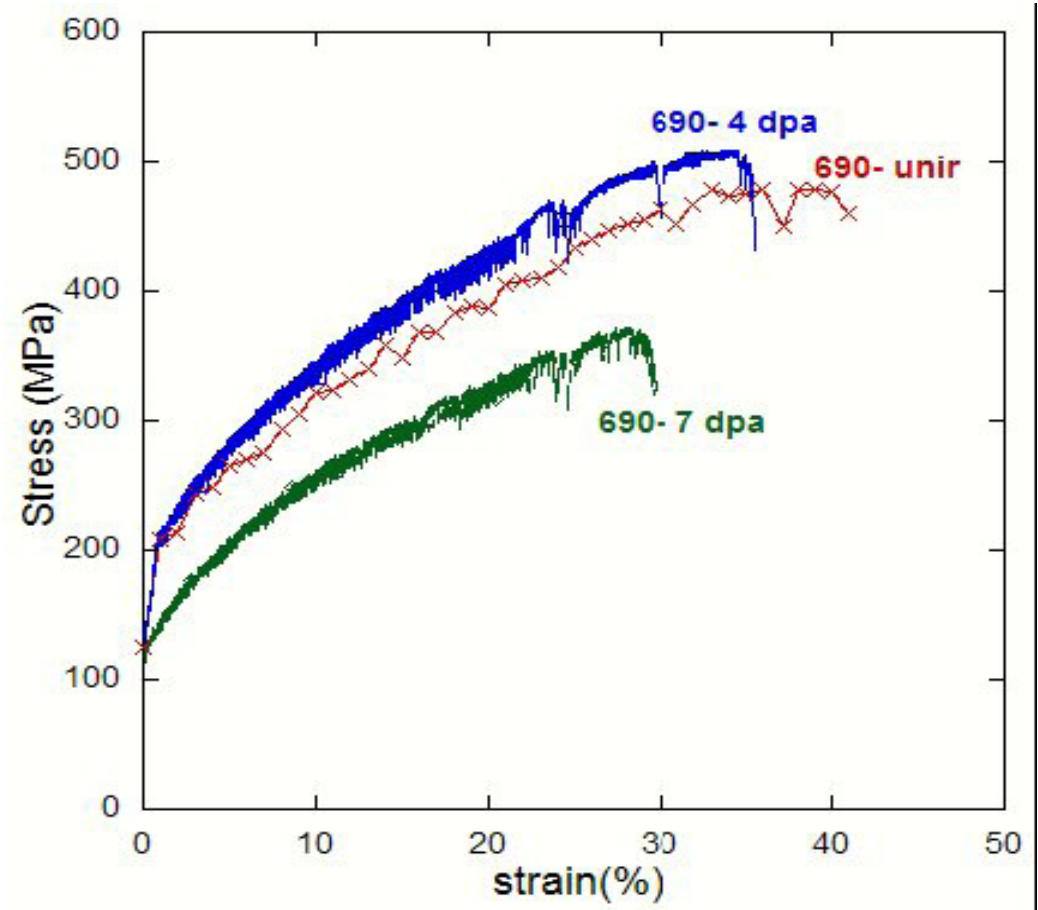
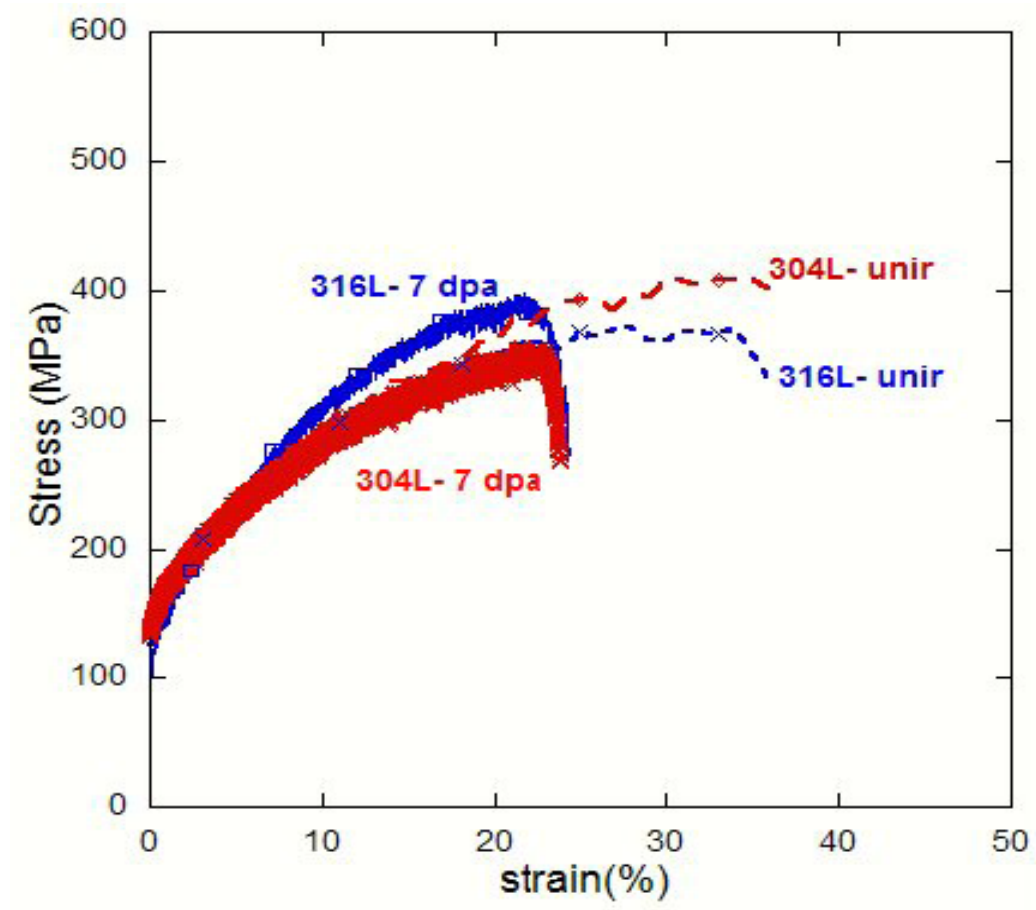

# Increased SCC susceptibility after irradiation

Unirradiated sample, showing less intergranular cracks

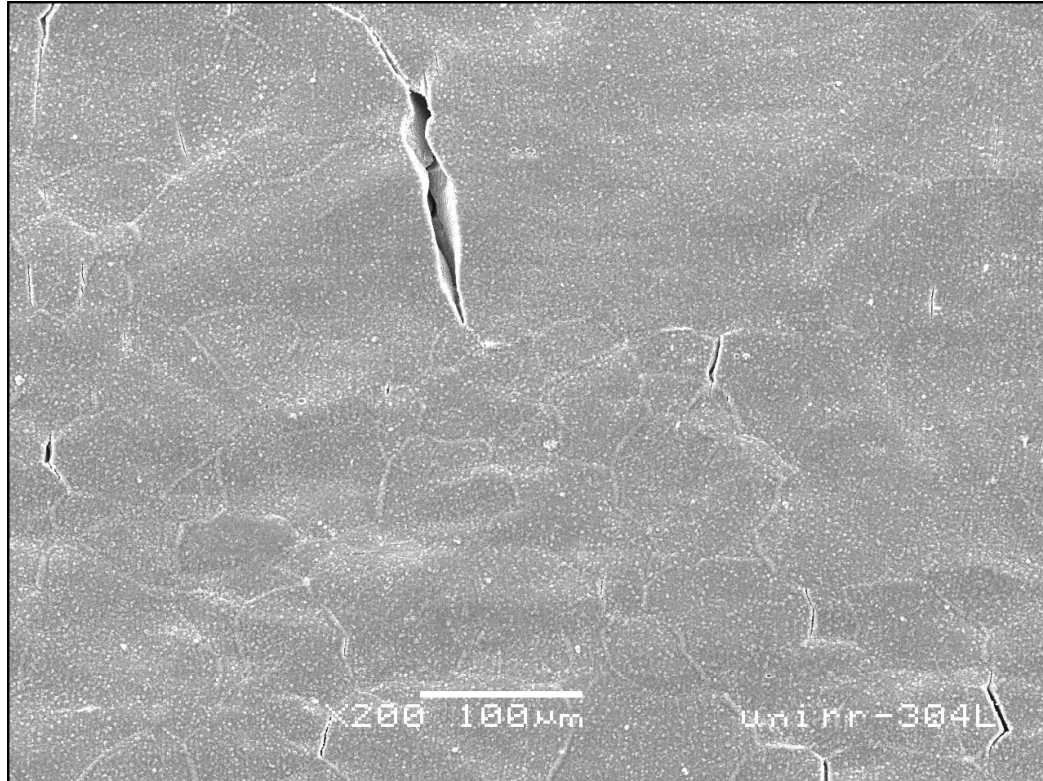

Irradiated to 7dpa, showing much more cracks

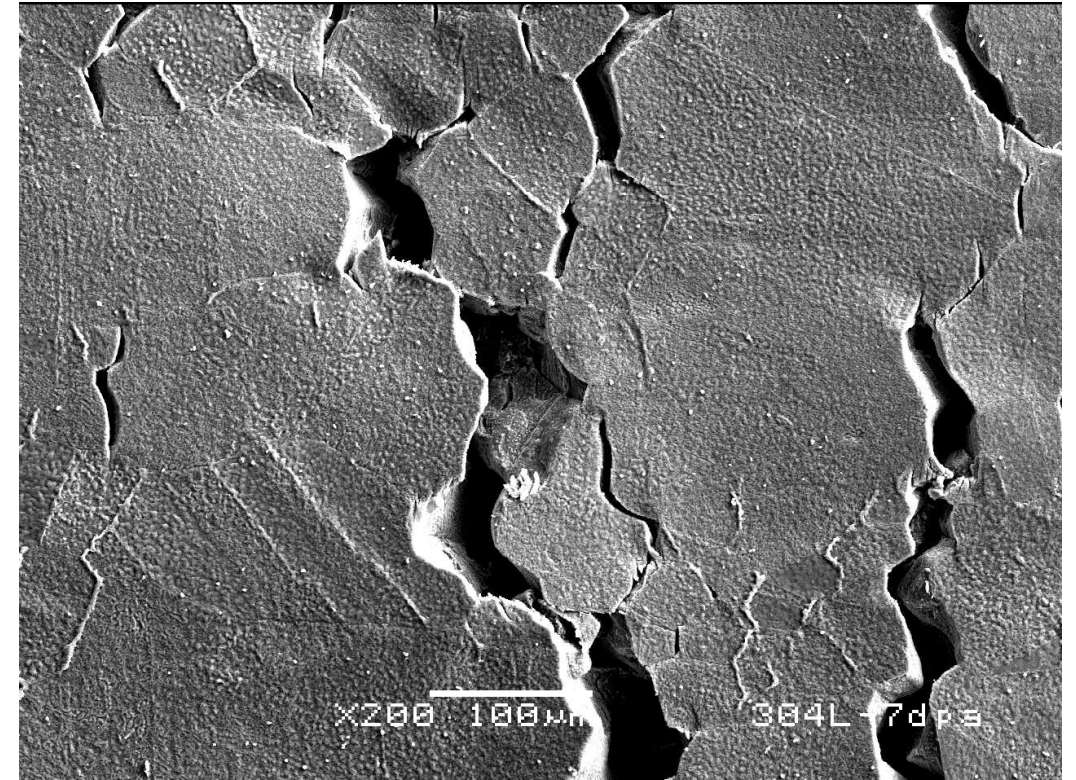

**Facing the high corrosion rate of candidate materials, irradiation damage is presently not a biggest concern, but we need to consider this point in R&D of novel materials.**

# Novel alloys



# R&D of novel alloys

## □ For general corrosion performances

- Increasing Cr up to 25 wt%
- Adding Al > 2.5%, Si ~1%.

## □ Strengthening by ODS or precipitations

- ODS increases YS upto ~300 MPa at 550 °C
- But ODS may introduce oxygen and defects

## □ Cracking mitigation

- Cold work increases creep and SCC
- Sensitization at operating temperature
- GB carbides and precipitation

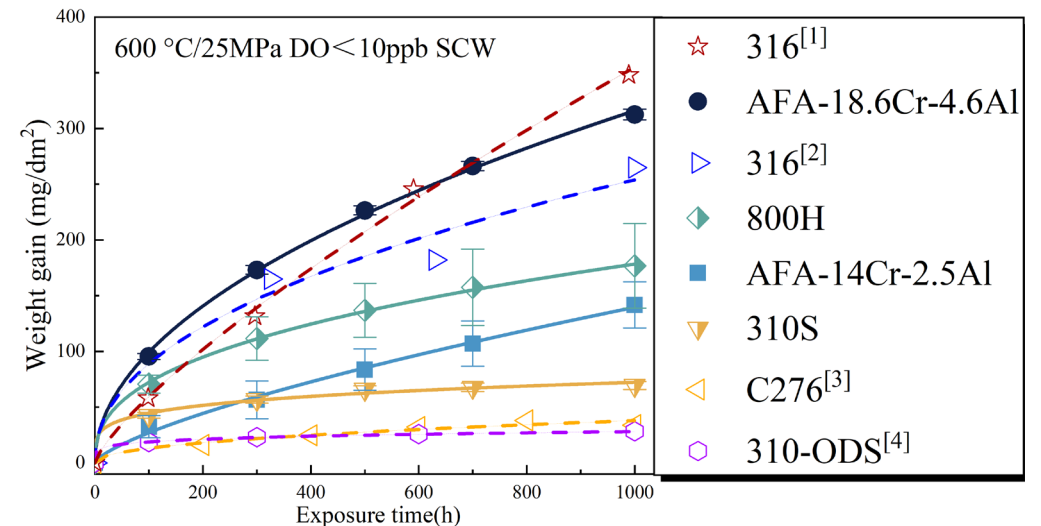
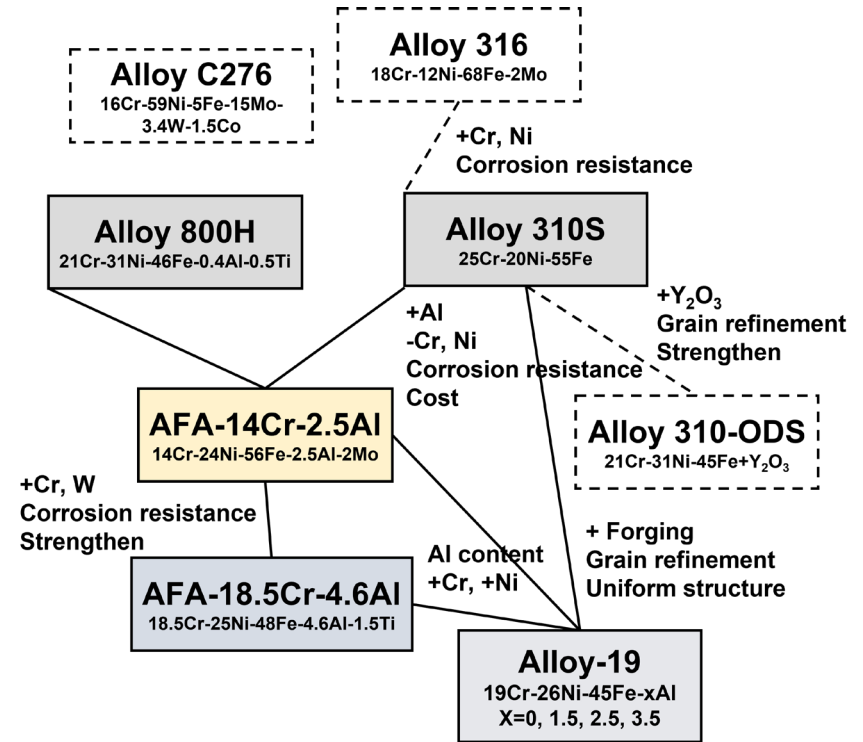

# High concentration Cr AFA alloys – effect of Al

## Al on microstructure:

- Precipitates volume fraction, morphology, types
- Precipitation of B2-NiAl, FeCr(sigma),
- Spheroidize Laves-Si<sub>2</sub>(Mo,Nb) phase
- Precipitation of BCC-Fe (delta) with 3.5 wt% of Al addition

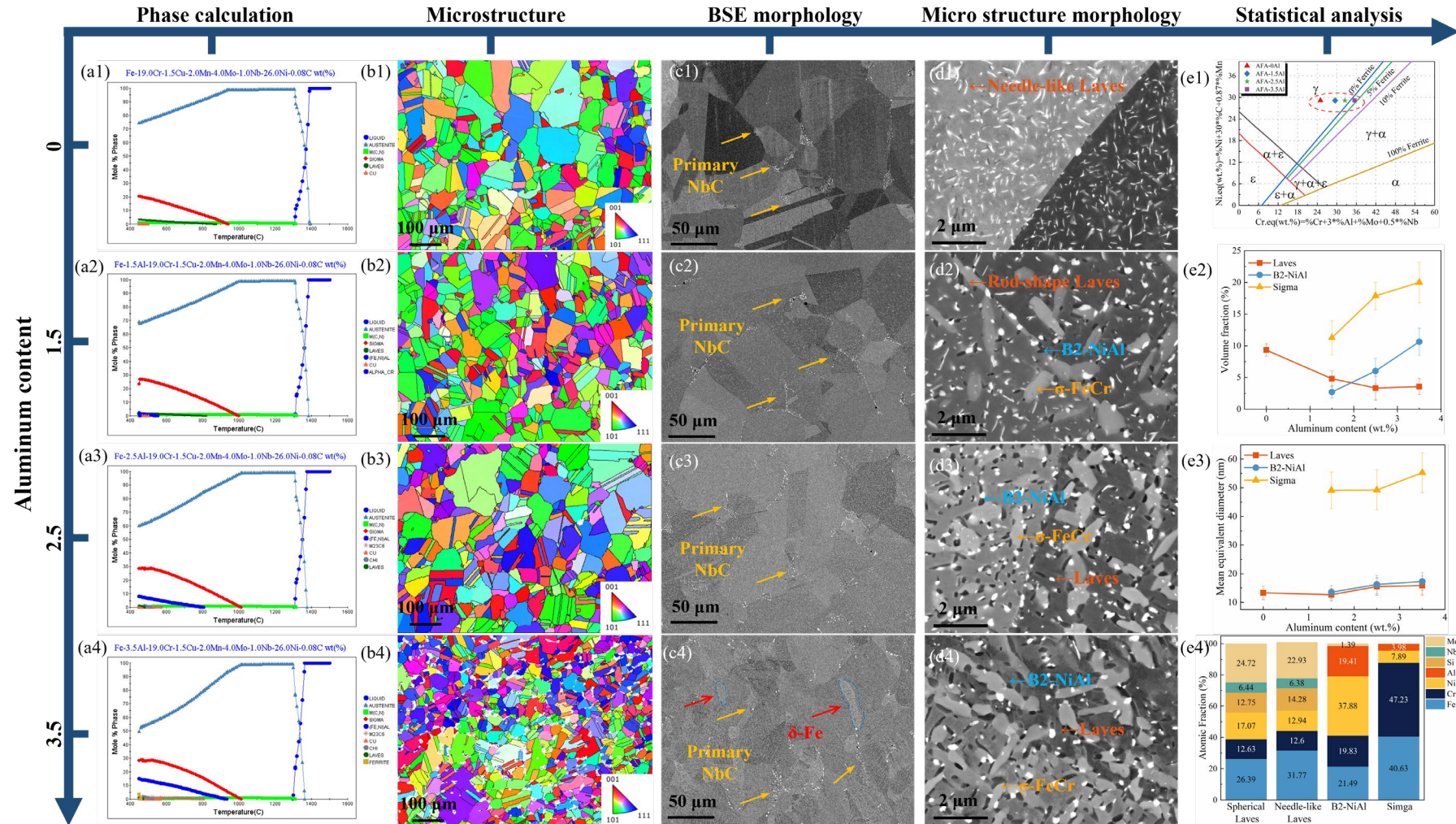

# High Cr AFA alloys – effect of Al on corrosion behavior

The addition of Al effectively improves the corrosion resistance

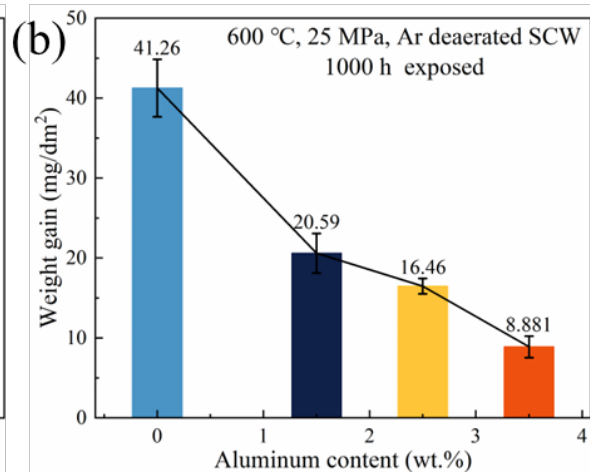
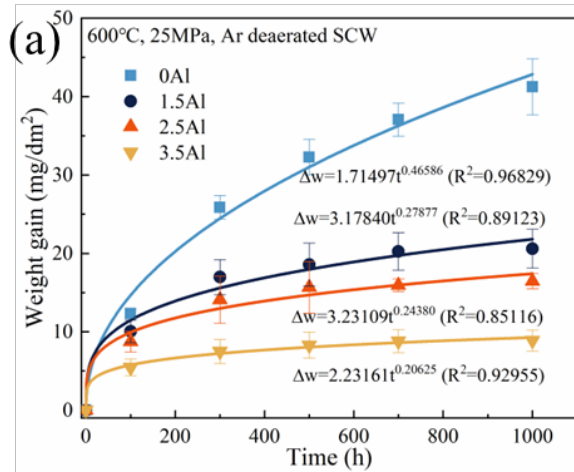

Relationship between corrosion resistance and oxide scale morphology

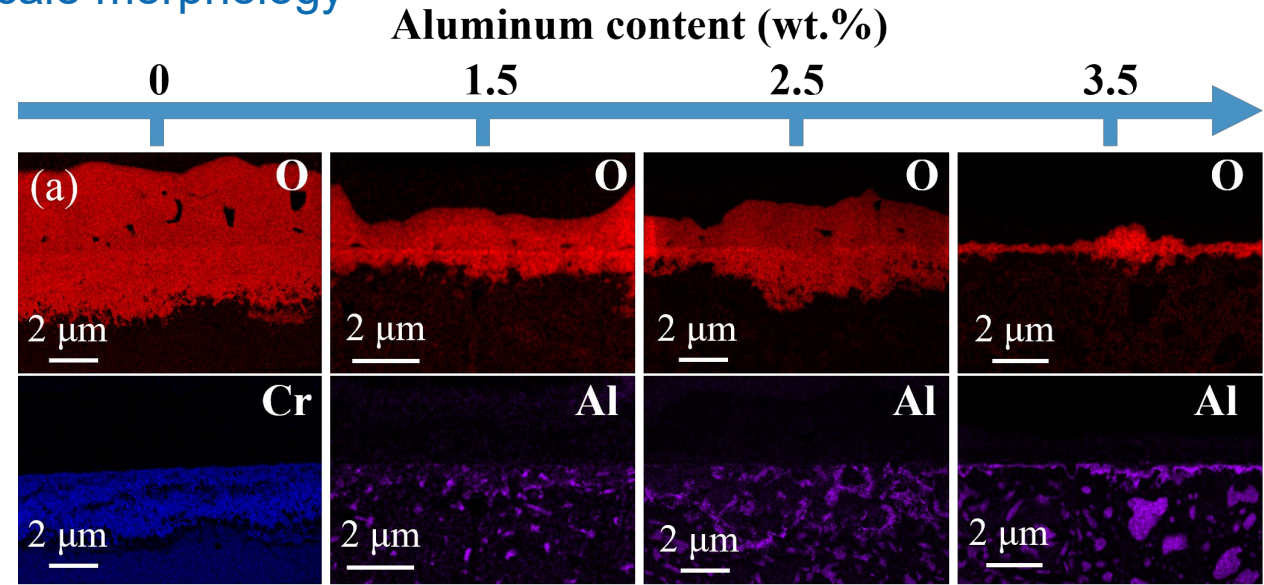

Independent and continuous Al<sub>2</sub>O<sub>3</sub> scale > Discontinuous Al<sub>2</sub>O<sub>3</sub> scale > Cr-Al mixed oxide scale > Cr<sub>2</sub>O<sub>3</sub>



# High Cr AFA alloys – effect of Al

Minor effect of BCC-Fe ( $\delta$ ) on  $Al_2O_3$  formation:  
 The precipitation of BCC-Fe ( $\delta$ ) needs to be avoided

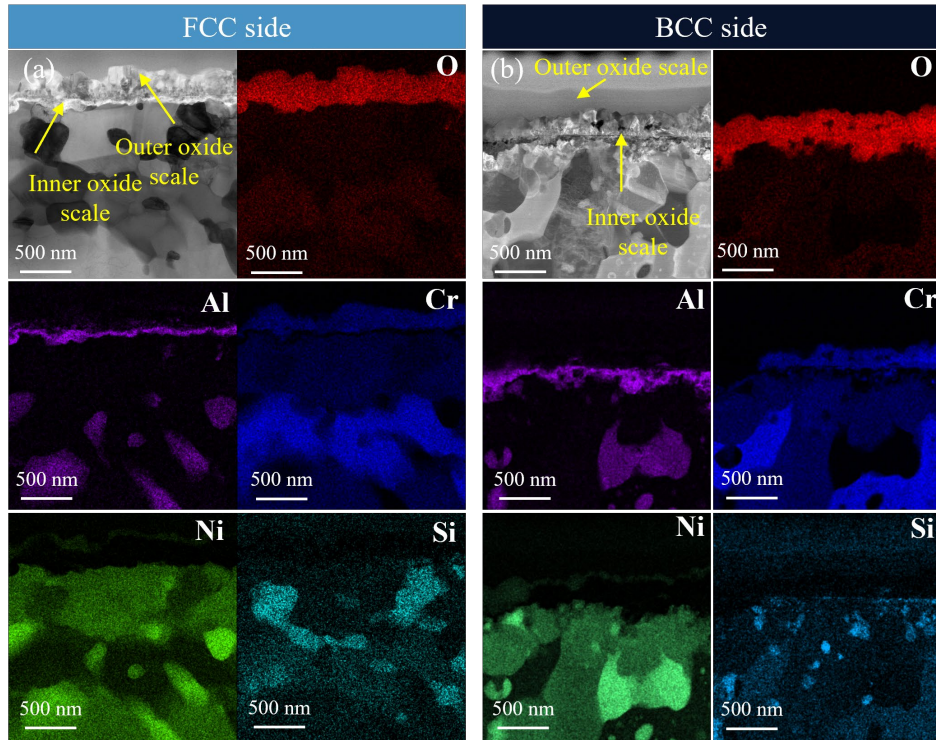

- $Al_2O_3$  scale: uniform in FCC side and fluctuate in BCC side

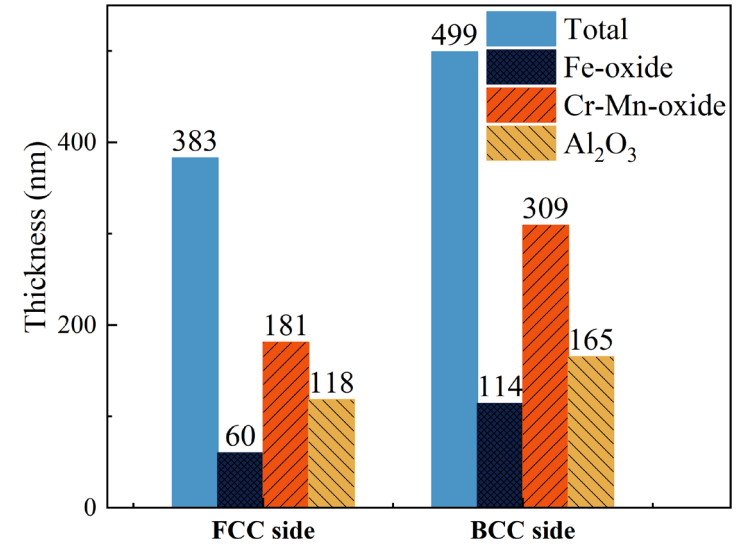

- The thickness variation is only 40 nm in two side

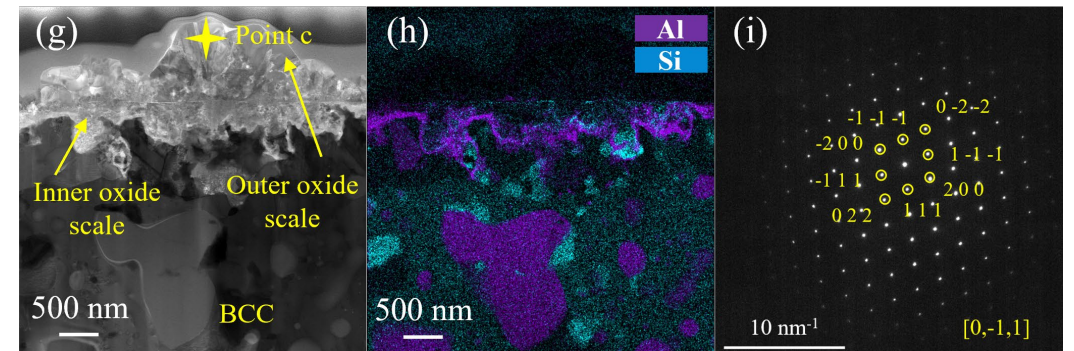

- Inhomogeneous distribution of Al in BCC side results in the fluctuation of  $Al_2O_3$  scale

# High Cr AFA alloys – effect of Al

The effect of Al element on SCC

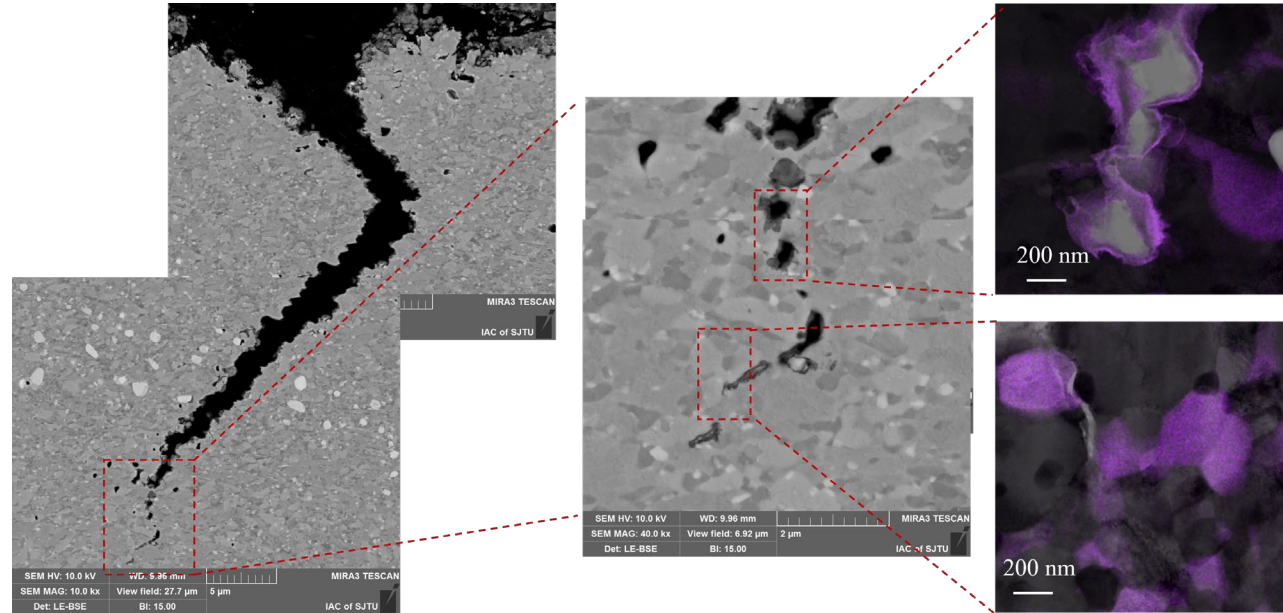
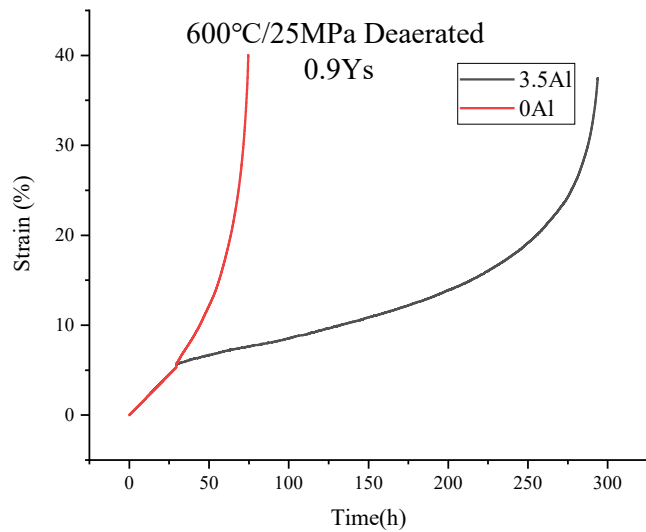

Crack initiation under constant load

- The  $\text{Al}_2\text{O}_3$  scale in crack tip hinders corrosion
- Precipitates impedes crack propagation



# High Cr AFA alloys – effect of Si

- Addition of Si improves the corrosion resistance effectively
  - ✓ The corrosion weight gain in SCW at 600 °C@25MPa decreases with the increasing Si concentration
  - ✓ The alloy containing 1.5% Si showed 10x lower corrosion rate than 310S stainless steel

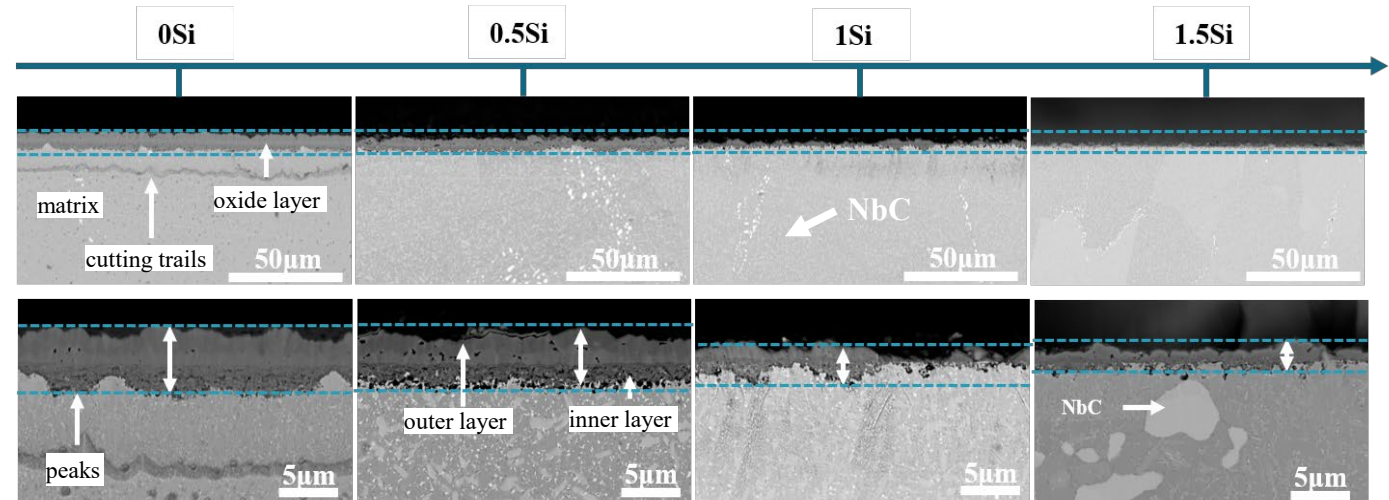
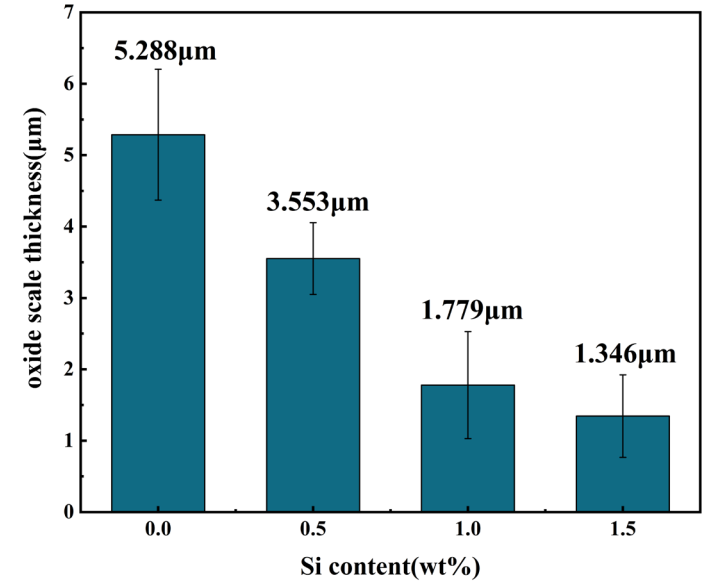
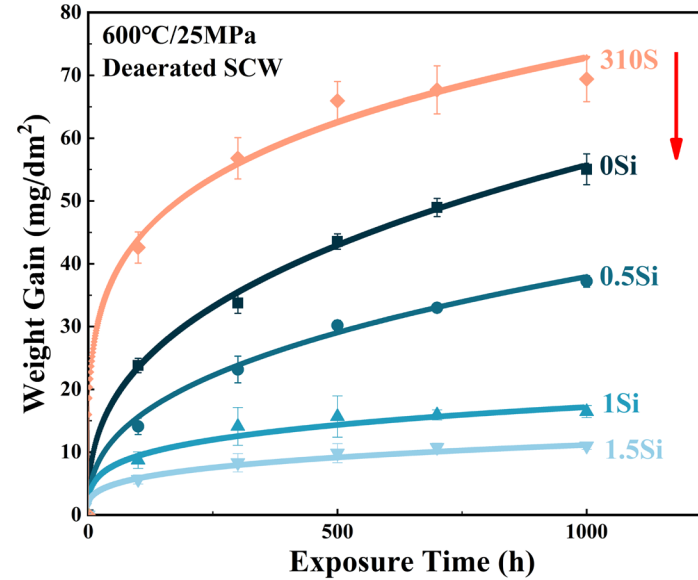

# High Cr AFA alloys – effect of Si

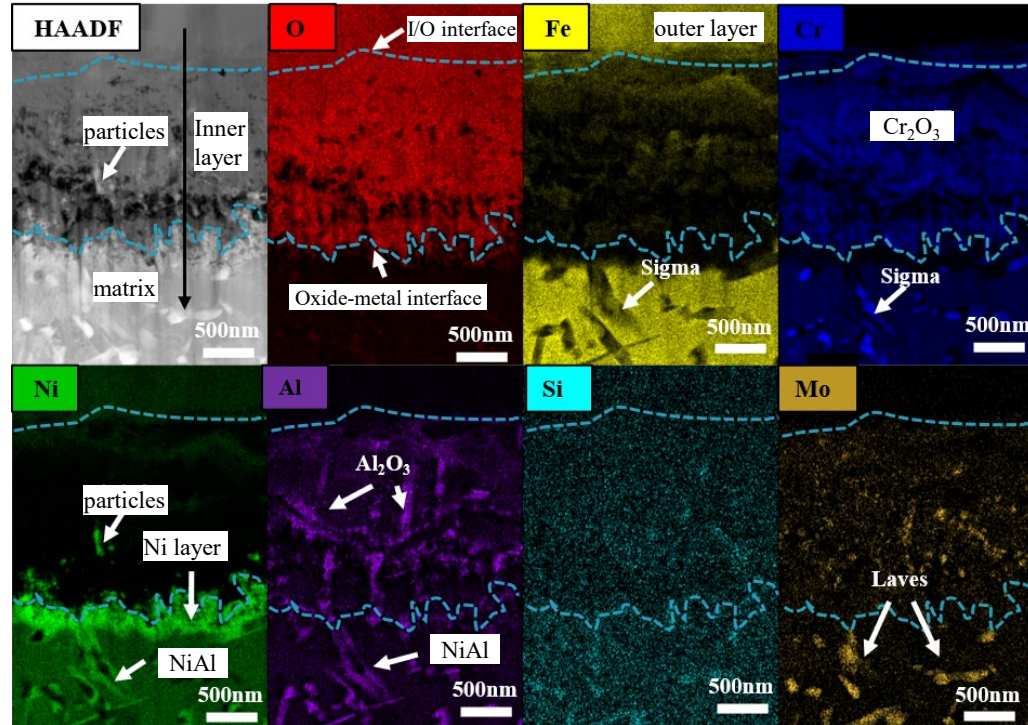

**Alloy with 0 Si:** No SiO<sub>2</sub> layer can be found in the protective oxide scale.

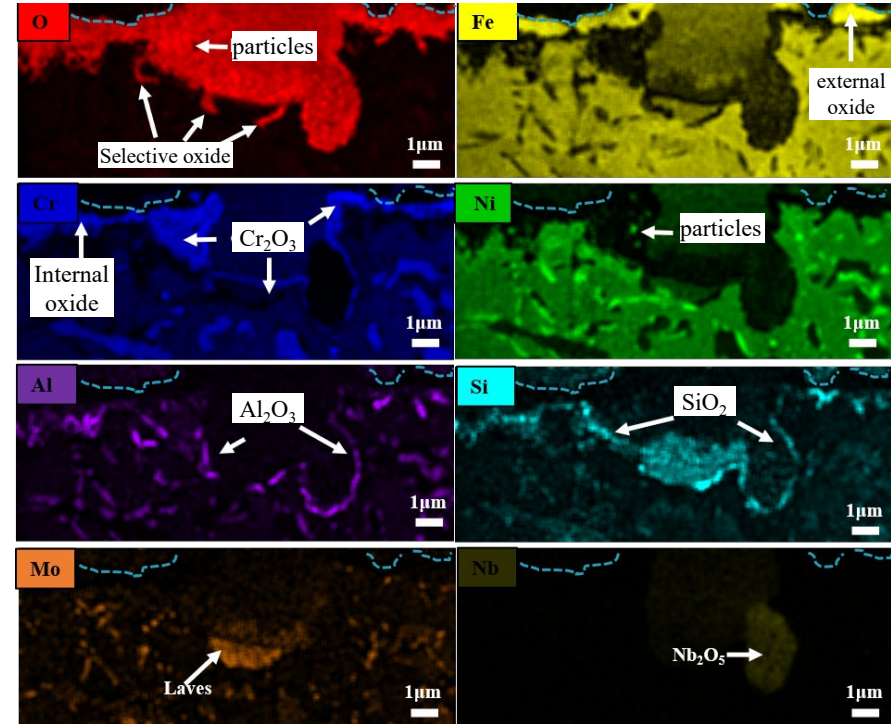

**Alloy with 1.5%Si:** A layer of SiO<sub>2</sub> can be found in the surface oxide scale together with Cr<sub>2</sub>O<sub>3</sub> and Al<sub>2</sub>O<sub>3</sub>. Synergistic effects of Cr, Al and Si on corrosion resistance is of great interest in our future study.



# High Cr ODS alloys

The addition of nano-size  $Y_2O_3$  refines the grain size, which may improve the high temperature strength.

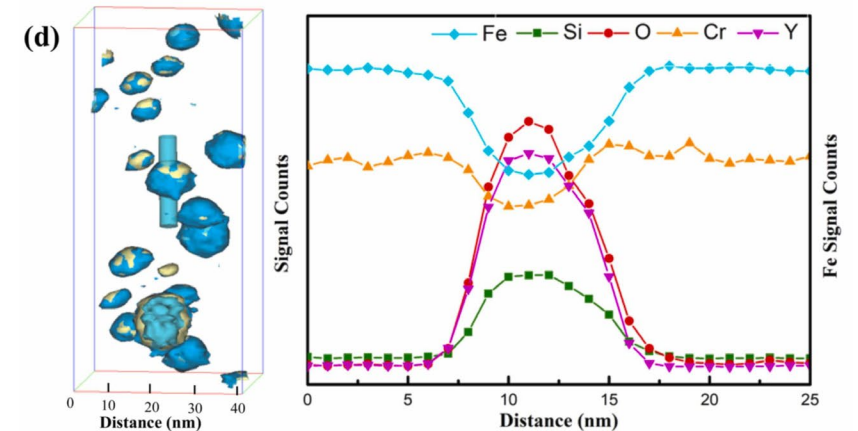
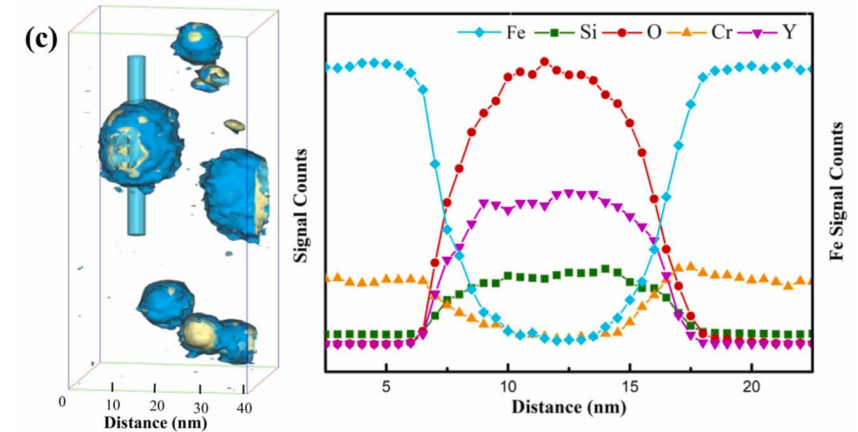
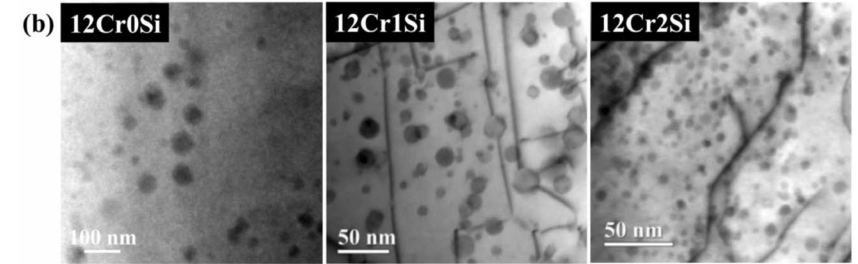
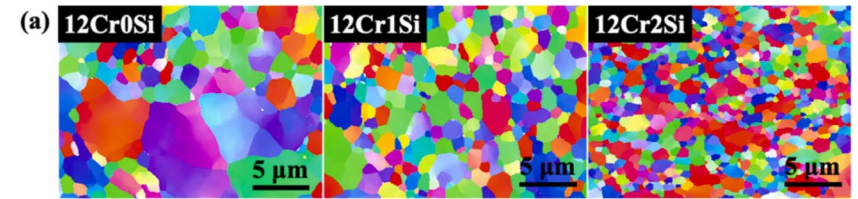
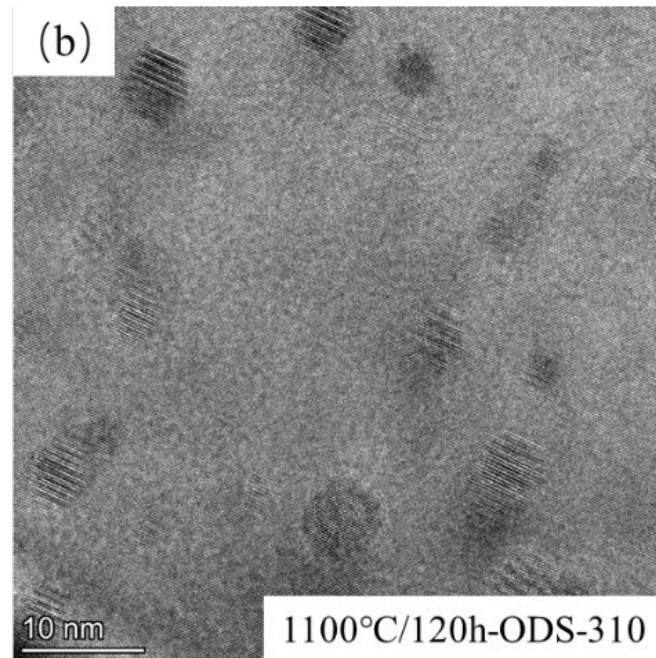
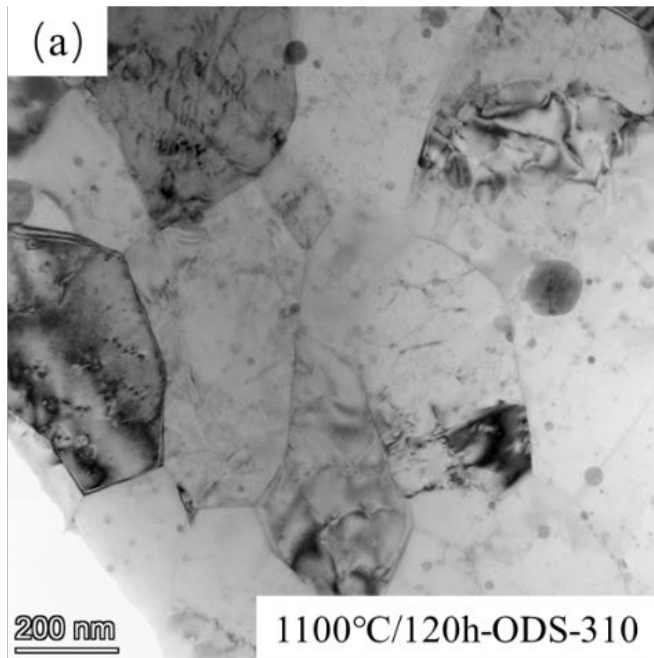

# High Cr ODS alloys

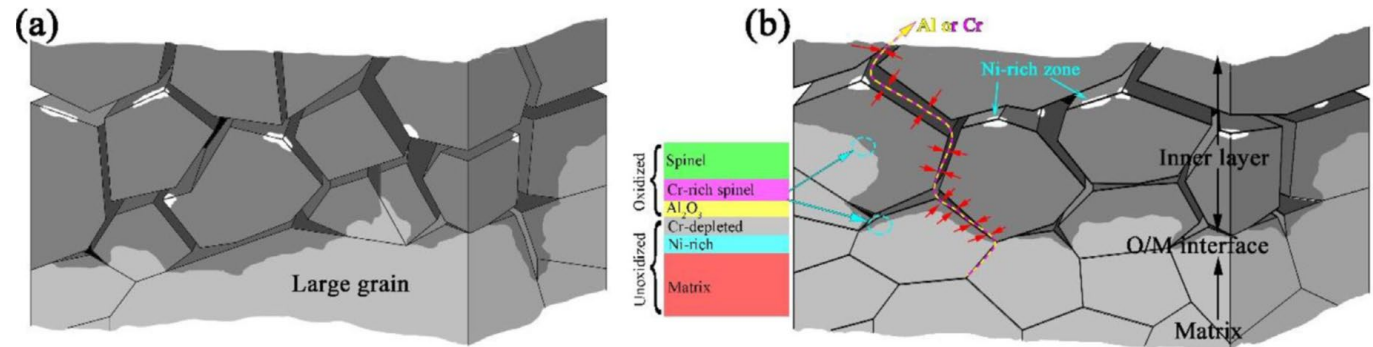
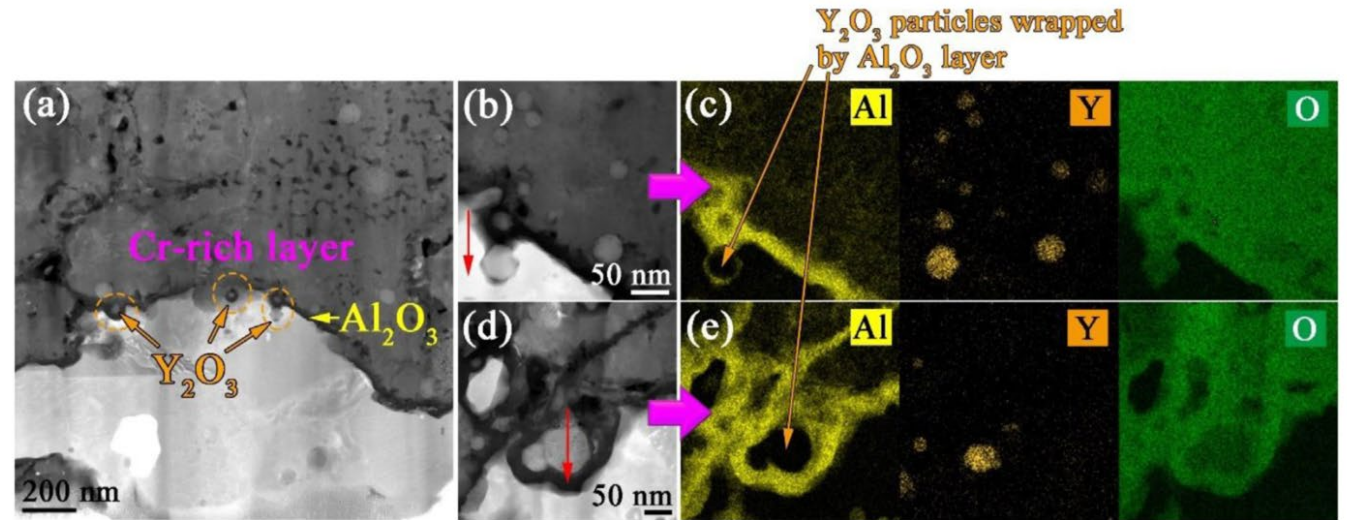
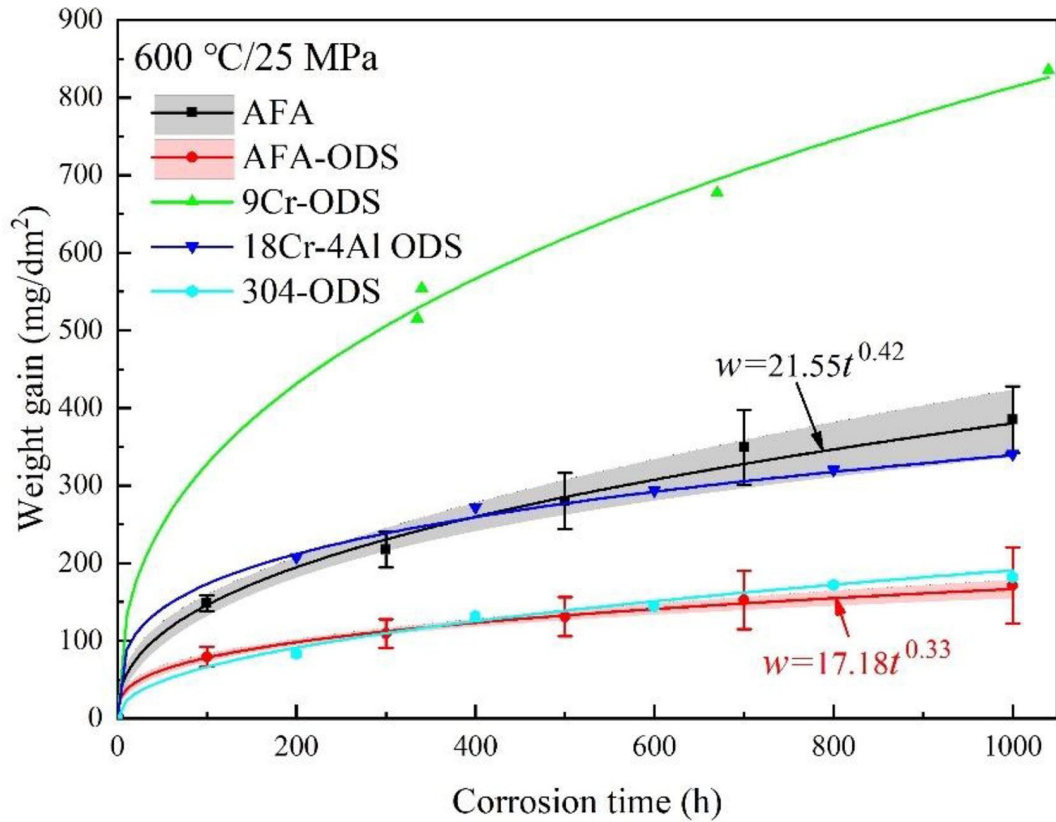



# Key points to obtain good data in our tests

## Formalization of testing procedures in SCW

- Specimen preparation: polish to mirror surface, removing mechanical effect, better to use vibration polishing. Removal of the cold worked surface is of great importance.
- When testing surface effects, prepare the surface carefully, homogeneity and reproducibility.
- Install at least two thermocouples in the autoclave, so that the temperatures above and below of the coupons are recorded.
- Water purity: maintain high purity water (low conductivity and TOC), stable pH, and specified dissolved gases. Maintain autoclave refresh rate until the same conductivity readings from outlet and inlet. So that, the water chemistry in autoclave is stable.
- When stopping the autoclave, 1) stop the autoclave heater; 2) stop the high pressure pump after autoclave temperature drops about 20 ° C; 3) gradually depressurize the autoclave down to about 2MPa, then close the valves of autoclave inlet and outlet, and let the autoclave to cool down.



# Obtaining the effect of creep on cracking

The creep CGRs can be measured after the SCC tests by removing water with argon in the autoclave to establish inert environment-no effect of corrosion.

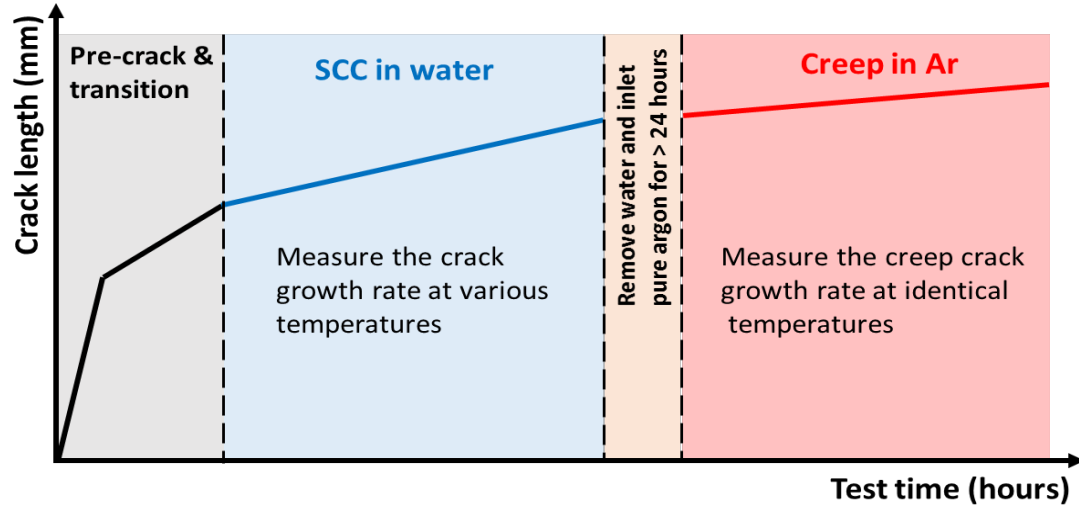

Critical rule on obtaining good crack growth rate data:

- getting reliable data on the same specimen
- change the testing conditions on the fly
- Only one parameter changed in one step
- Repetition to confirm the data.

## Test System

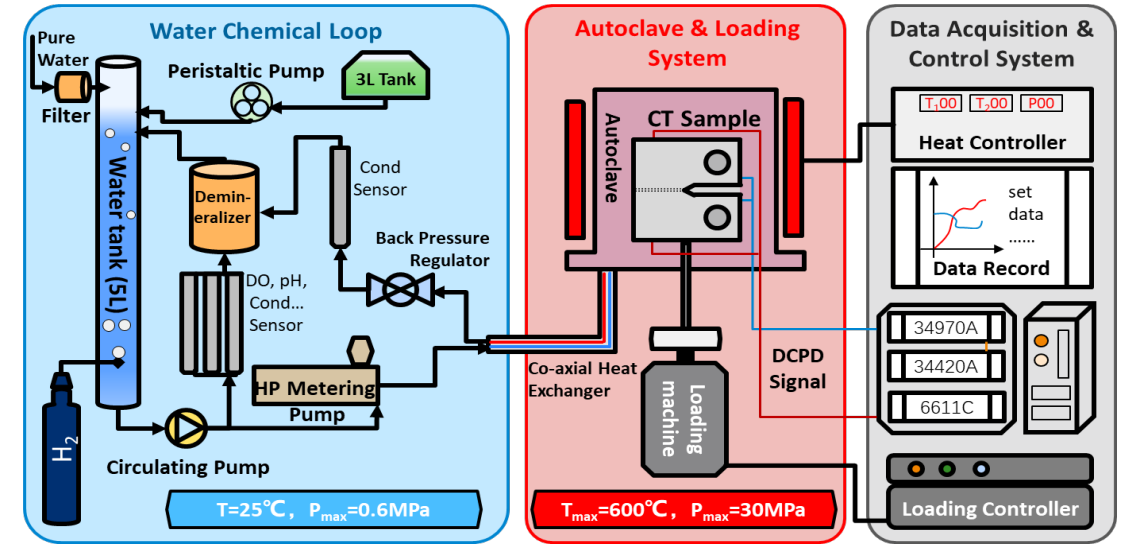

## Post-test analysis

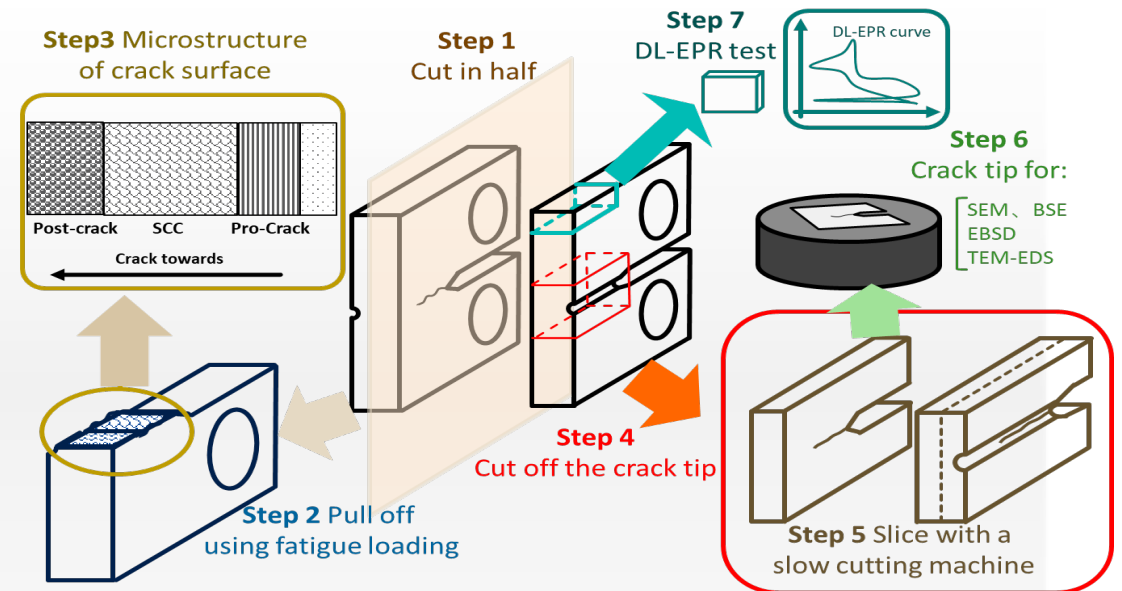

# Takeaways

## SCWR concept is facing great challenges in cladding materials

- No commercial materials are available at present
- R&D of novel material is facing a great gap in corrosion, creep and cracking performances

## The ideas for R&D of novel SCWR cladding materials

- High Cr + moderate Al% + Si%
- ODS can be considered to strengthen GB
- Bulk or surface hardening by cold working is necessary to reduce general corrosion rate



# Upcoming Webinars

Date	Title	Presenter
27 September 2023	EPRI Virtual Reality Training	Robert Eller, EPRI, USA
31 October 2023	The Nuclear Workforce of The Future – Opportunities and Needs for The International Nuclear Sector	Callum Thomas, Thomas THOR, UK
02 November 2023	MOOK: The knowledge management method applied to a Gen IV project. The continuation of a successful story	Gilles Rodriguez, CEA, France