

# Metal Fuel for Prototype Generation-IV SFR: Design, Fabrication and Qualification

**Dr. Chan Bock Lee**

**Korea Atomic Energy Research Institute  
28 October 2021**



# Metal Fuel for Prototype Generation-IV SFR: Design, Fabrication and Qualification

**Dr. Chan Bock Lee**

**Korea Atomic Energy Research Institute  
28 October 2021**

## Meet the Presenter

**Dr. Chan Bock Lee** has been working at Korea Atomic Energy Research Institute (KAERI) since 1989. At KAERI, he worked on the design, fabrication and post-irradiation examination of UO<sub>2</sub> fuel for the commercial PWRs in Korea. After that, he worked on the development of diverse fuels for PWR, research reactor and VHTR. Since 2007, he has worked on metal fuel development for SFR. He earned his BS and MS in Nuclear Engineering from Seoul National University in South Korea and his PhD in Nuclear Engineering from MIT, USA. He served as Division Director of Fuel Development at KAERI, Chair of Nuclear Fuel and Materials Division in Korea Nuclear Society, and Co-Chair of OECD/NEA Nuclear Innovation-2050 Fuel and Fuel Cycle Subgroup



# Content

- Introduction
- Fuel development for PGSRF
  - Fuel design
  - Fuel fabrication
  - Fuel qualification
- Summary

# Introduction

## □ Pyro-electrochemical fuel recycling in SFR

- From spent fuel, pyro-electrochemical processing recovers uranium and transuranic elements (TRU) together to fabricate metal fuel for SFR
- Transmutation of minor actinides in PWR spent fuels can reduce environmental burden and repository space, and enhance utilization of uranium resource

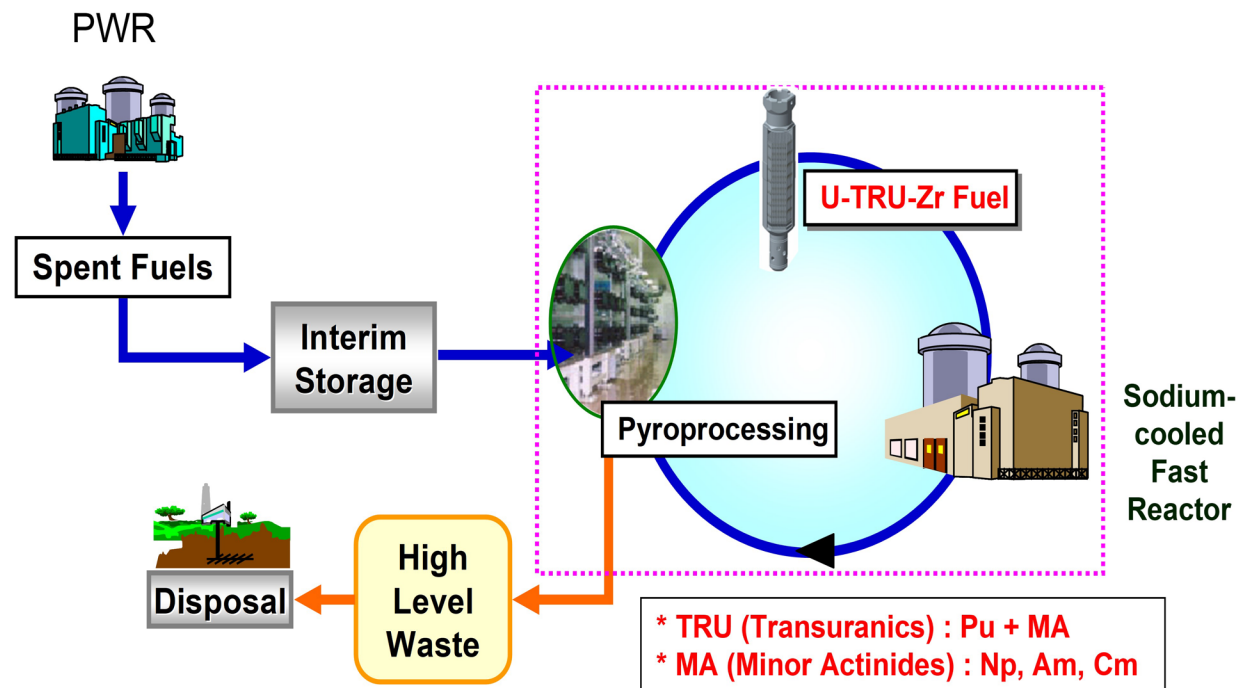

## ❑ Metal Fuel for Prototype Generation-IV SFR

- Inherent passive reactor safety
- Enhanced utilization of uranium resource
- Efficient transmutation of minor actinides
- Proliferation resistance with pyro-electrochemical fuel recycling

➤ To meet the targets of Generation IV SFR

- Sustainability, Safety, Economy and Proliferation Resistance

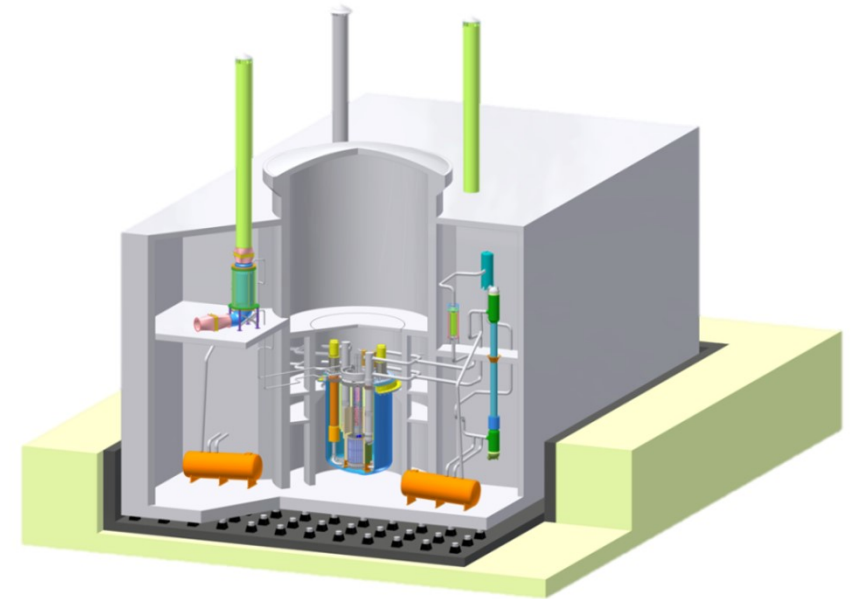

# Design Characteristics of PGSFR

| General |                                  | Requirement   | Remarks  |
|---------|----------------------------------|---|--|
| General | General requirement              | Demonstration of TRU transmutation coupled with pyro-processing | Management of PWR spent fuel for sustainable use of nuclear energy                         |
|         | Fuel                             | U-Zr (Initial core),<br>U-TRU-Zr (Equilibrium)                  | Step-by-step qualification of fuel   |
|         | Electric capacity                | 150 MWe   | Minimum power capacity for sufficient neutron flux for fuel/cladding qualification         |
|         | Core outlet temperature          | 545 °C  | New fuel/cladding development, high temperature structural design, high thermal efficiency |
|         | Design life time/Capacity factor | More than 60 yr/75 %  |  |
|         | SSE(Safe Shutdown Earthquake)    | 0.3 g   | Introduction of seismic isolation technology   |
| Safety  | CDF                              | $10^{-6}$ /reactor-yr   | Requirement of Gen-IV reactor  |
|         | Grace time for operator action   | More than 2 hours in DBE, BDBE                                  | Lesson learned from Fukushima accident   |
|         | SBO                              | More than 3 days in SBO   | Lesson learned from Fukushima accident   |

# Core of PGSFR

| Main Parameters                                    | U Equilibrium  |
|--|----------------|
| Thermal/Electric Power [ $MW_{th}/MW_e$ ]          | 392/150        |
| Coolant Temperature (inlet/outlet) [ $^{\circ}C$ ] | 390 / 545      |
| Fuel Form / U-235 Enrichment [wt.%]                | U-10%Zr / 19.2 |
| Cycle Length [EFPD]                                | 290            |
| Structure Material (Cladding & Reflector)          | FMS            |
| Number of Batches (Inner/Outer Core)               | 4 / 5          |
| Active Core Height [cm]                            | 90.0           |
| Fuel Pin Diameter [cm] / P/D Ratio                 | 0.74 / 1.14    |
| Uranium Inventory [Ton]                            | 7.33           |
| Average/Peak Burnup [GWd/Ton]                      | 66 / 105       |
| Average Power Density [ $W/cm^3$ ]                 | 213            |

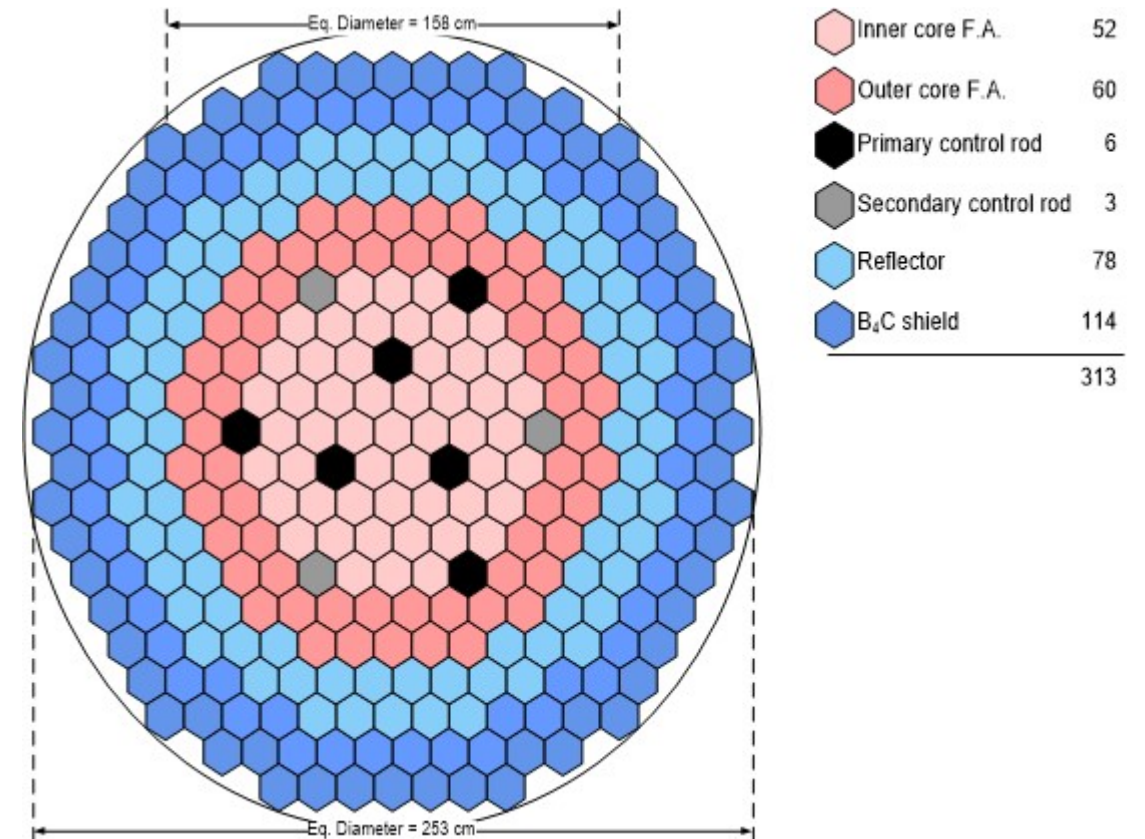



# Fuel Assembly of PGSFR

- Fuel material: U-Zr & U-TRU-Zr
- Active fuel length: 900 mm
- Fuel rod length: 2,240 mm

- Cladding & duct material: FMS (FC92/HT9)
- Cladding diameter & thickness: 7.4 mm & 0.5 mm
- Overall assembly length: 4,550 mm

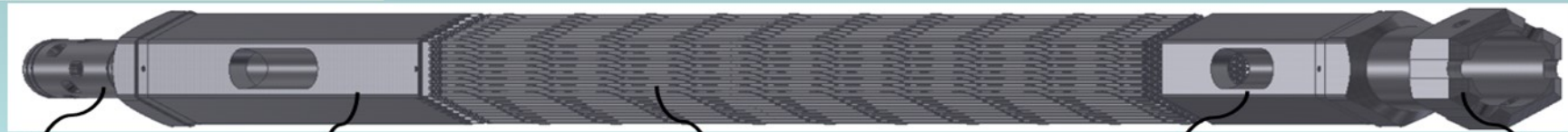
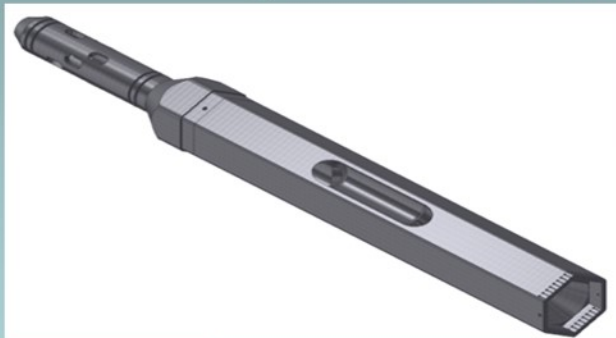

Nose piece

Lower reflector

Fuel pin

Upper reflector

Handling socket

# Fuel Design

## ❑ Fuel Design Consideration

- Maximum discharge burnup
- Peak fuel power and temperature
- Peak cladding fast neutron fluence

## ❑ Fuel Design Basis and Limit

- Fuel temperature : melting and eutectic melting
- Cladding integrity : creep, swelling, CDF(Cumulative Damage Fraction) and strain
- ✓ Fuel integrity to be maintained

## ❑ Fuel Design

- Dimensions, shape, arrangement, and configuration
- Selection of materials of fuel components

# Irradiation Performance of Metal Fuel

## ☐ Fuel

- Fission gas release
- Fuel swelling and axial growth
- Migration of elements (TRU, Zr and RE) during irradiation

## ☐ Cladding

- Creep deformation
- Irradiation swelling
- Ductility reduction

## ☐ Fuel-Cladding Interaction

- FCCI : Eutectic melting, cladding wastage
- FCMI : cladding mechanical failure

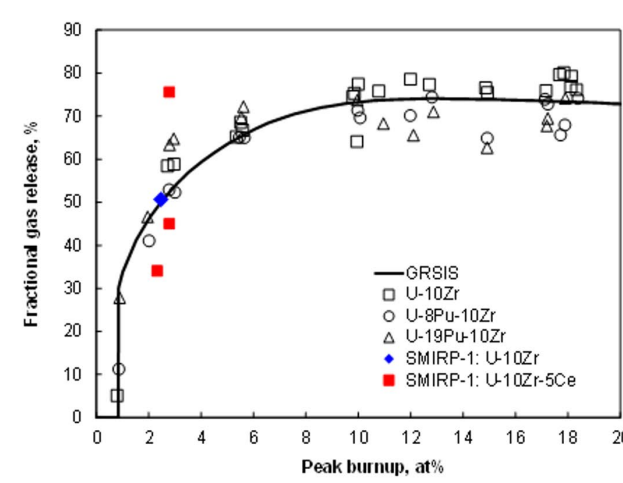

Fission gas release

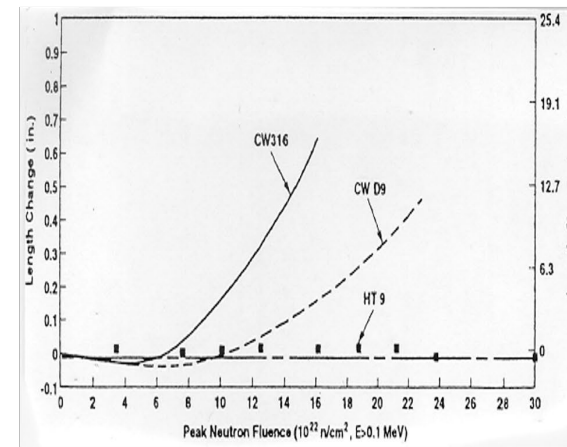
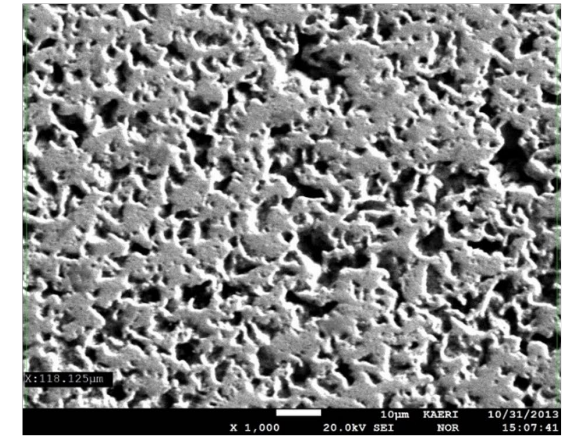

Cladding swelling

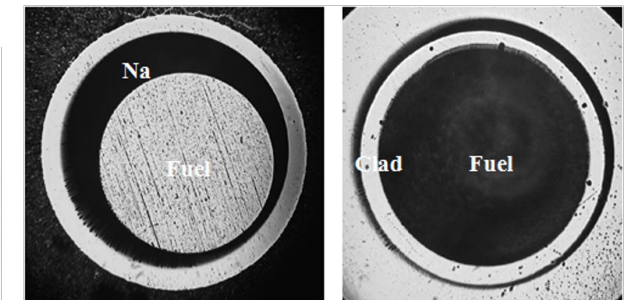

Before irradiation After irradiation

Fuel Swelling

# Fuel Design Analysis

## ☐ Fuel Rod

- Design criteria for normal operation(NO) and operational transients
  - Fuel centerline temperature, cladding strain and CDF(Cumulative Damage Fraction)
  - Fuel cladding chemical interaction(FCCI)

| Core       | Max. clad. mid-wall temp., °C | Total cladding strain, %<br>(Criterion: < 1.0 %) | CDF<br>(Criterion: < 0.05) | Max. fuel centerline temp., °C<br>(Criterion: < 1,237 °C) |
|------------|-------------------------------|--|----------------------------|---|
| Inner core | 652                           | 0.46   | $9.42 \times 10^{-3}$      | 714   |
| Outer core | 650                           | 0.54   | $2.35 \times 10^{-2}$      | 693   |

## ☐ Fuel Assembly

- Design criteria for NO and DBA(Design Base Accident)
  - Ensure FA structural integrity and functional requirements
  - Prevent brittle failure of duct during fuel handling

# Fuel Fabrication

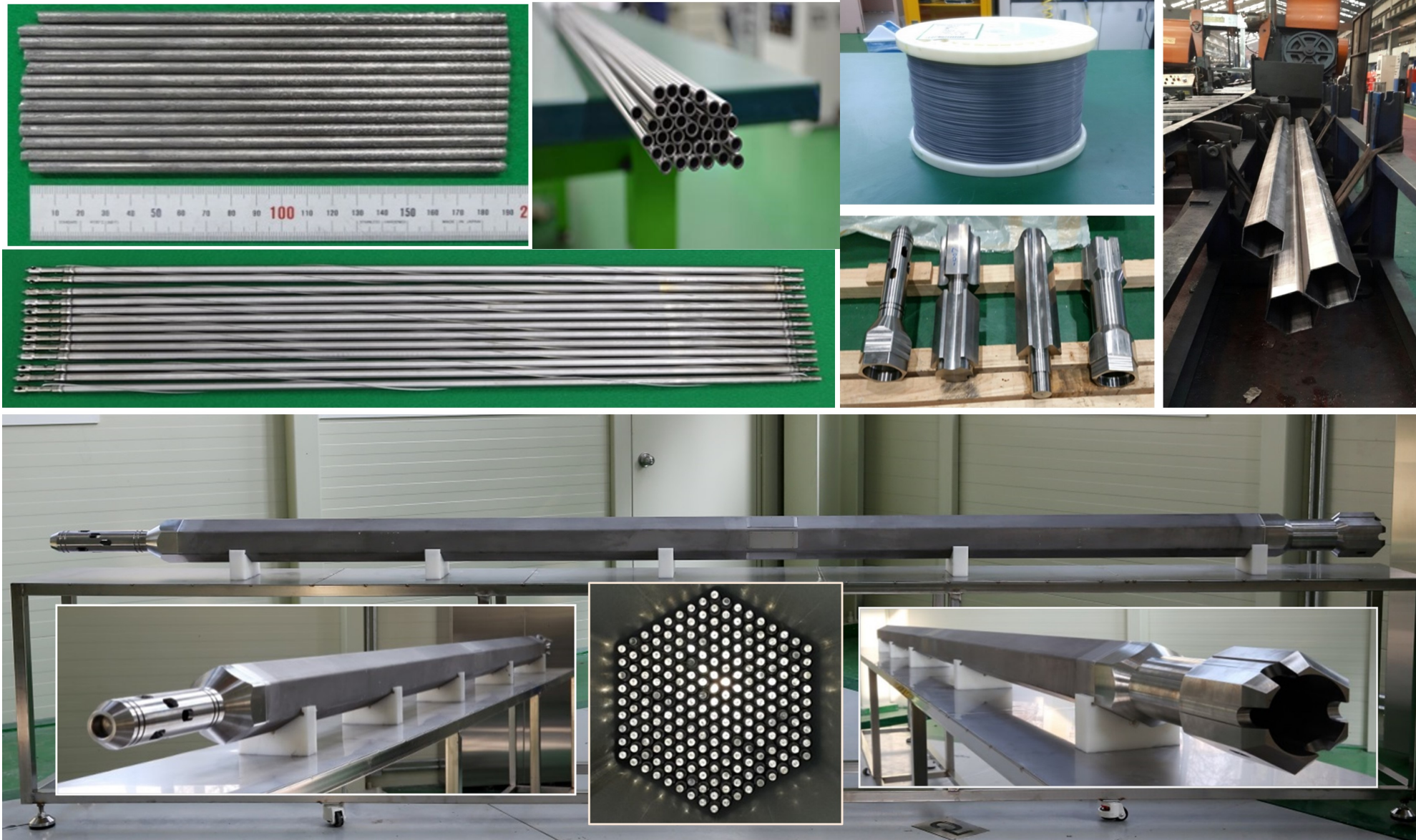

# Fuel slug casting

- ❑ Injection casting equipment
  - Batch size : 2.5kg/batch(Lab.), 20kg/batch(Eng.)
  - Slug dimension :  $\Phi 5.4$ -L300mm
- ❑ Fuel slug fabrication
  - U-Zr-Ce-Mn slugs with varying compositions
  - U-(5,10,15)Zr, U-10Zr-(2,4,6)RE, U-10Zr-RE-5Mn
  - Casting conditions(temperature, pressure, heating rate, time) optimization
- ❑ Quality of fuel slugs meeting fuel specification
  - Dimension :  $5.54^{+0.1}_{-0.08}$  mm
  - Zr content :  $10 \pm 1.0$  wt. %
  - Impurity content : C+N+O+Si < 2,000 ppm

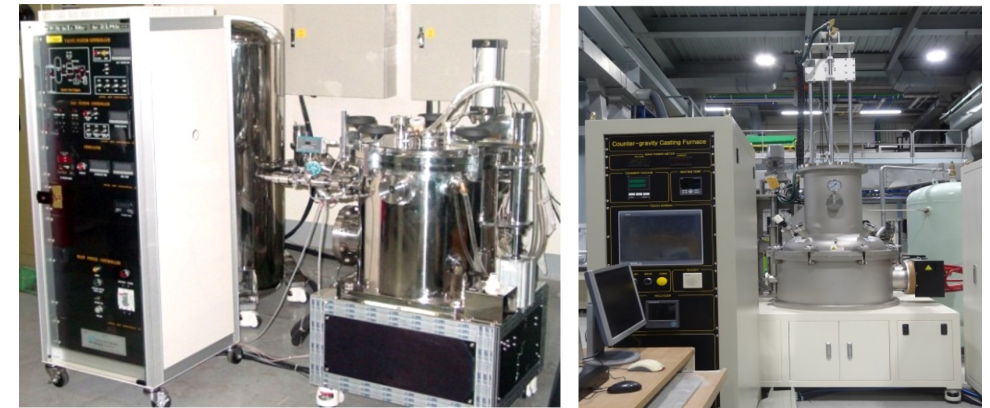

Injection casting

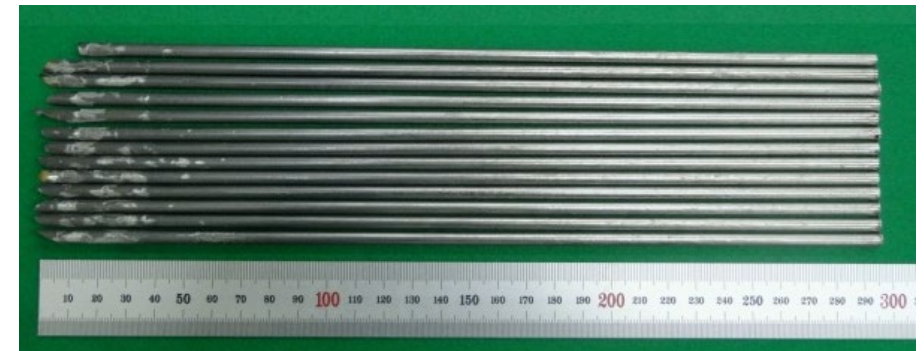

U-10Zr fuel slugs

| U (%) | Zr (%) | Si (ppm) | C (ppm) | O (ppm) | N (ppm) |
|-------|--------|----------|---------|---------|---------|
| 89.9  | 10.1   | 151      | <10     | 210     | <10     |
| 89.7  | 10.2   | 153      | <10     | 220     | 10      |
| 89.6  | 10.3   | 162      | <10     | 230     | 20      |

Fuel slug composition

# Steps for Cladding Tube Fabrication

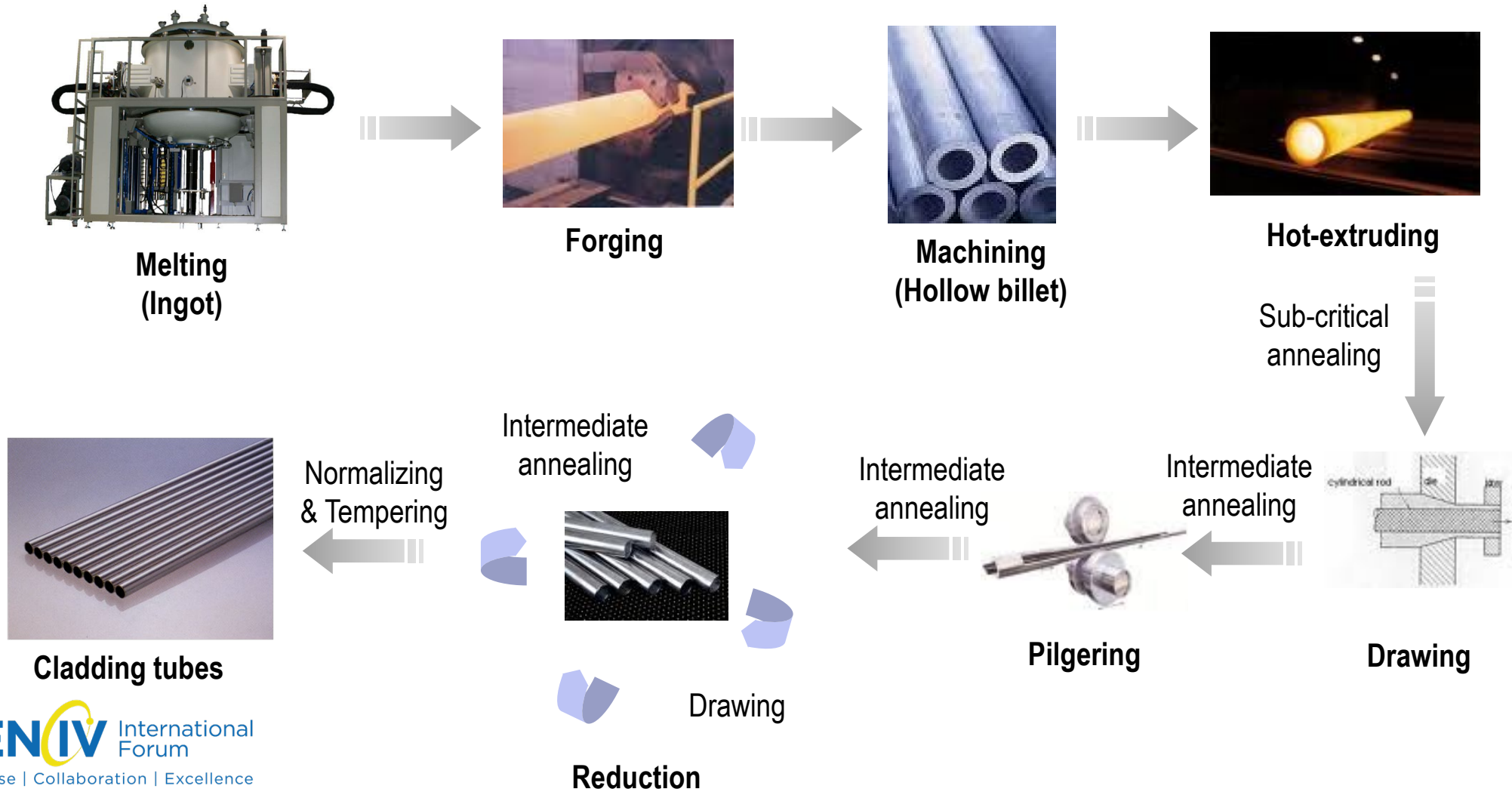

# Cladding Tube Fabrication

- ❑ Hollow billet fabrication
  - Large ingot(1 ton) melting (vacuum induction melting)
  - Forging (1200°C)
  - Machining hollow billet (OD 180mm)
- ❑ Tube fabrication
  - Hot extrusion (OD 54mm)
  - Pilgering and drawing
  - Intermediate heat treatment
  - Cleaning
  - Final heat treatment
- Final dimension of cladding tube :  
OD7.4mm x WT0.56mm x L3,000mm



1 ton ingot



Hot extrusion



Extrusion bar



Drawing



Intermediate tube



Cladding tube



# Advanced Cladding Materials Development

- ❑ Advanced FMS cladding alloy design and manufacturing
  - 38 alloys in 3 batches
  - Vacuum induction melting (30kg)
  - Hot rolling (thickness : 15mm)
  - Heat treatment (normalizing at 1050°C, tempering at 750°C)
- ❑ Performance tests
  - Microstructure examination
  - Sodium compatibility tests
  - Creep/tensile tests
    - Creep rupture strength (650°C) improved by more than 30 % from HT9

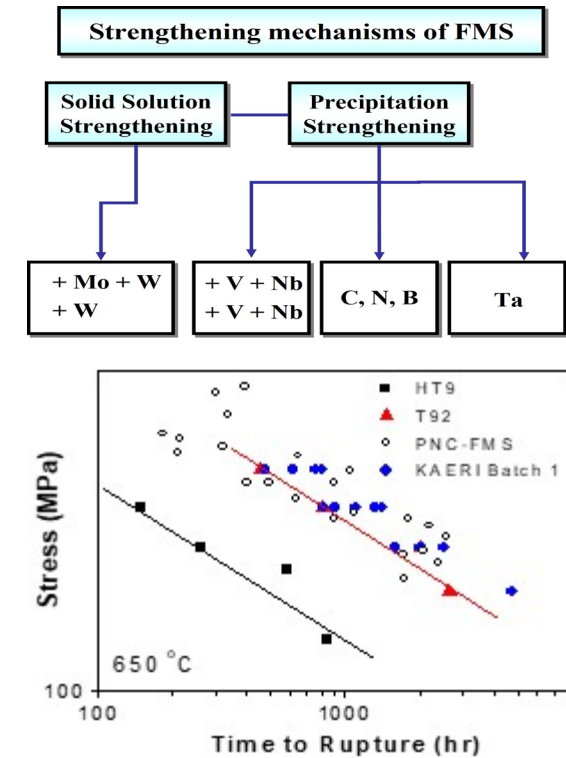

Creep test

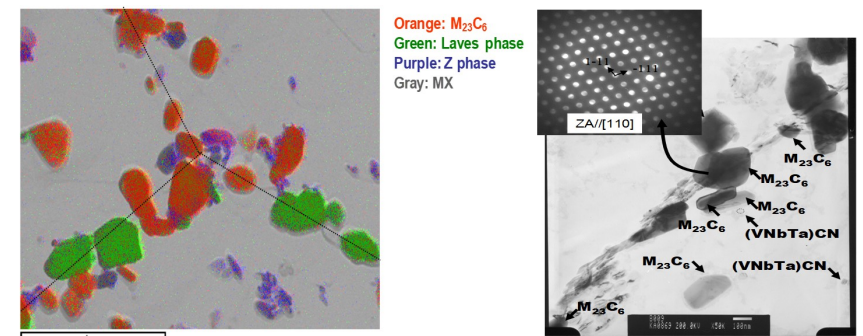

Microstructure



# Wire and Duct Fabrication

- ❑ Fabrication of wire for fuel rod
  - Material : HT9
  - Ingot : VIM (1 ton)
  - Rolling (30pass) : OD 8.5mm wire
  - Drawing 7 times : **OD 0.95mm wire**
  
- ❑ Fabrication of duct
  - Material : HT9
  - VIM & ESR (3 ton ingot)
  - Hot forging at 1200°C : OD 200mm
  - Mother tube : Piercing
  - Drawing
  - Heat treatment
  - **Width 126mm, thickness 3mm, length 4m**



Wire



Rod for fabrication of duct

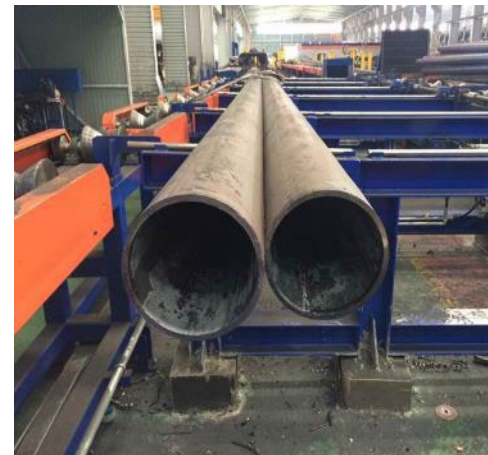

Mother tube

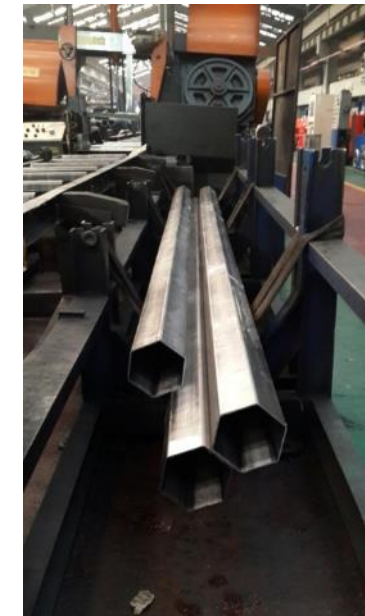

Duct

# Barrier between Fuel and Cladding

- ❑ Barrier to prevent interaction between fuel and cladding
  - Eutectic melting at high temperature
  - Degradation of cladding by rare earth fission products
- ❑ Investigation of diverse barriers
  - Effective barrier material : Cr, V,  $\text{Cr}_2\text{O}_3$  ..
  - Barrier fabrication methods : electroplating, oxidation, nitrification, metal liner..
  - Barrier on fuel slug : Surface oxidation of metal fuel slug

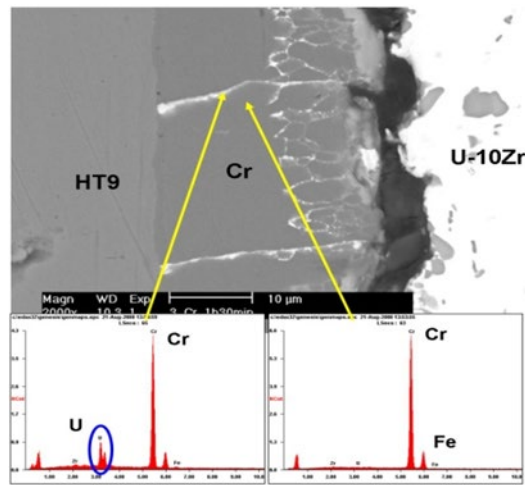

Cr Electroplating  
(800°C/25 hr)

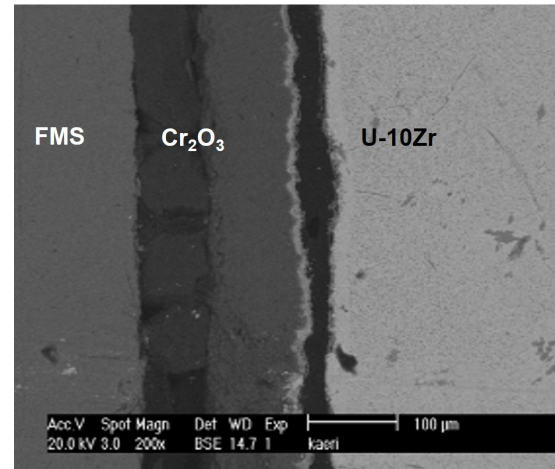

$\text{Cr}_2\text{O}_3$   
(800°C/25 hr)

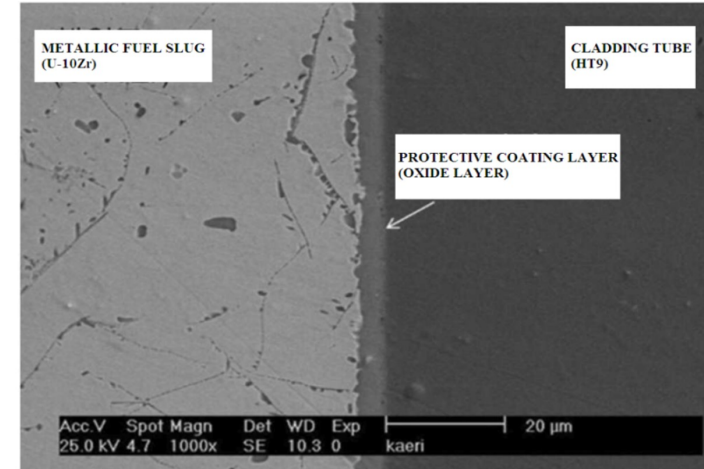

UO<sub>2</sub>  
(800°C/25 hr)

# Cr electroplating for barrier

- ❑ Manufacture of Cr-electroplated cladding
  - 20  $\mu\text{m}$  of Cr layer was plated at the inner surface of the cladding tube (5.8~7.4mm OD)
  
- ❑ Performance evaluation
  - Out-of pile test
    - Out-of pile diffusion couple test
    - Mechanical test (uniaxial tension, biaxial burst)
  - In-pile test
    - Irradiation test in HANARO (182EFPD, 3at% BU)
    - Cr was effective in preventing inter-diffusion between fuel and cladding

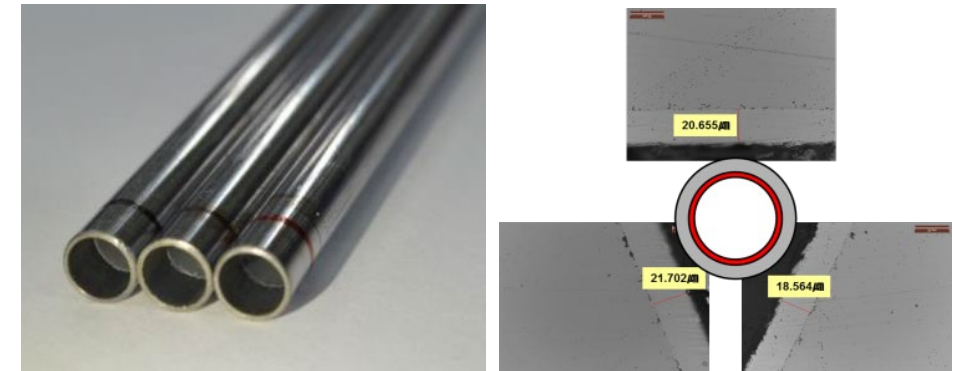
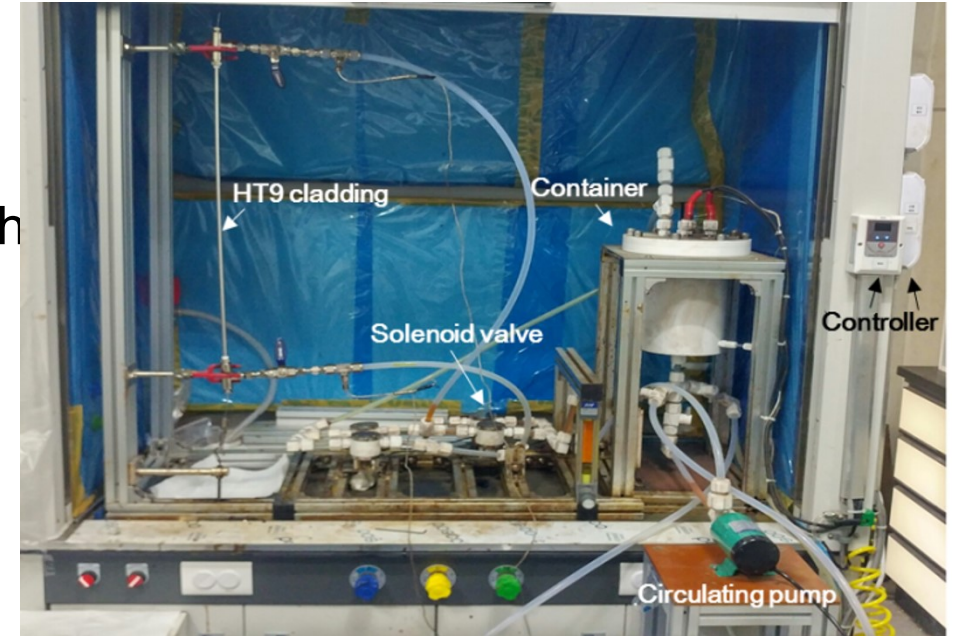

Cr-electroplated cladding tube

# Irradiation Test in HANARO

- ❑ Objective
  - Fuel slug & Cr barrier performance test
- ❑ 1st HANARO(thermal reactor) test
  - 12 rodlets (6 U-10Zr & 6 U-10Zr-5Ce, Cr barrier)
  - Cladding diameter: 5.5 mm
  - 3 at% burnup for 182 EFPD & PIE done
- ❑ 2nd HANARO test : planned
  - 12 rodlets (6 U-10Zr & 6 U-10Zr-4RE, Cr barrier)
  - Cladding: HT9, FC92
  - Two cladding diameter (5.5 & 7.4 mm)
  - Peak inner cladding temp.(PICT): 650 °C
  - 6 at% burnup irradiation(plan)

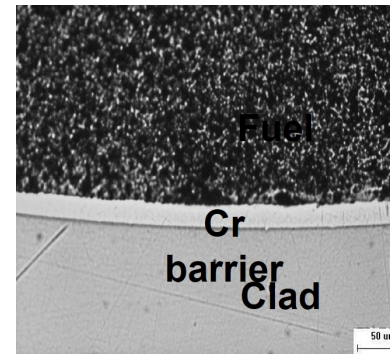
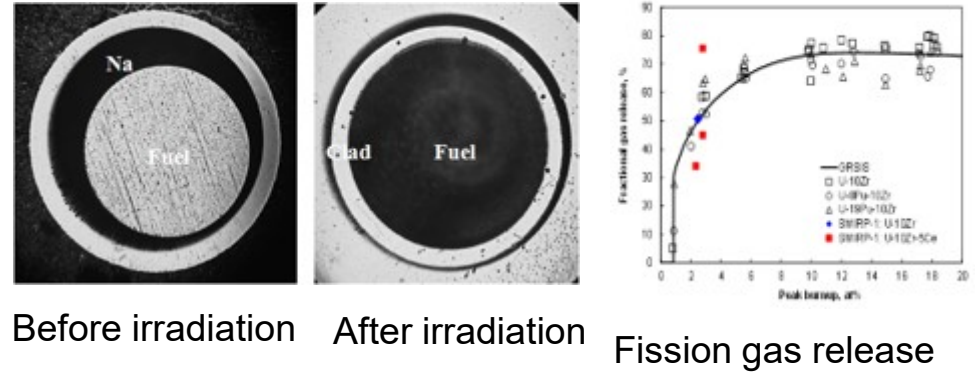

Cr barrier

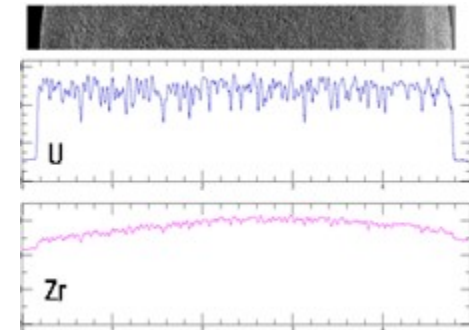

Element distribution

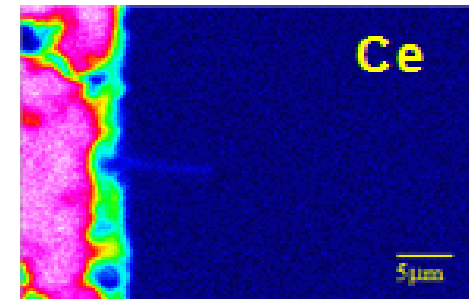
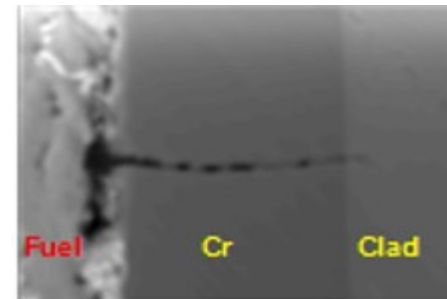
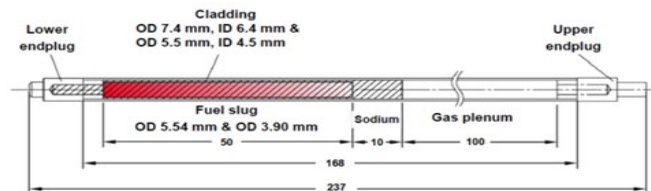
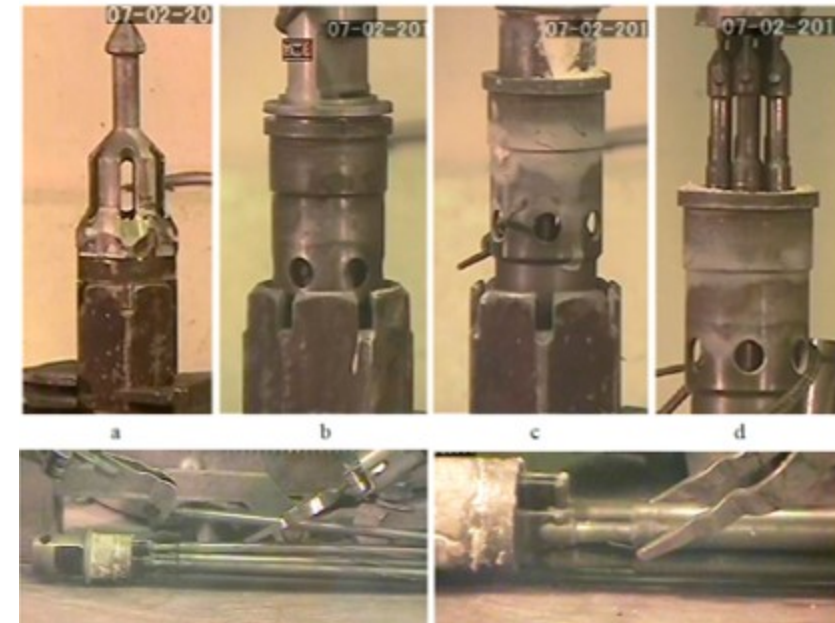
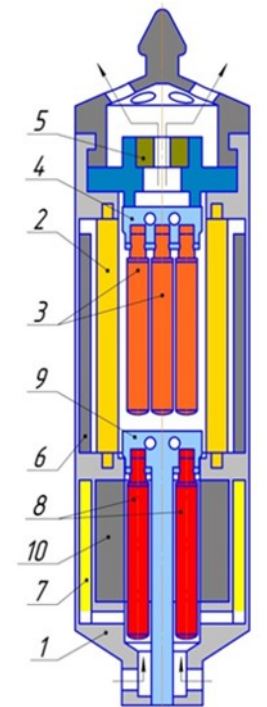

Image Mapping of U-Zr-Ce/Cr barrier



## Irradiation test in BOR-60

- ❑ Irradiation rig in BOR-60(fast reactor)
  - Fuel rod: U(LEU)-10wt%Zr (length: 185 mm)
  - ZrH<sub>x</sub> rod(moderator) installed to increase power of test fuel rod using LEU
- ❑ Irradiation conditions
  - Peak linear power: 364~319 W/cm
  - Peak cladding temperature: 650~617 °C
- ❑ Results
  - Cladding integrity is checked at every cycle
  - Interim NDE of three fuel rods were made at 3 at%: appearance, gamma scanning, cladding profilometry
  - Irradiation test (7 at.%) was completed in May 2020
  - Extension of irradiation test to 10 at.% burnup(planned)



# Cladding Irradiation Test in BOR-60

- ❑ Cladding test condition in BOR-60
  - Irradiation of cladding tube (FC92 and HT9) in 2 MTRs(Material Test Rig)
  - Irradiation test temperature
    - MTR-1 :  $600^{\circ}\text{C} \pm 30^{\circ}\text{C}$
    - MTR-2 :  $650^{\circ}\text{C} \pm 32^{\circ}\text{C}$
  - Irradiation dose achieved (in 2020. 08)
    - MTR-1 : 46.7 dpa
    - MTR-2 : 77.5 dpa

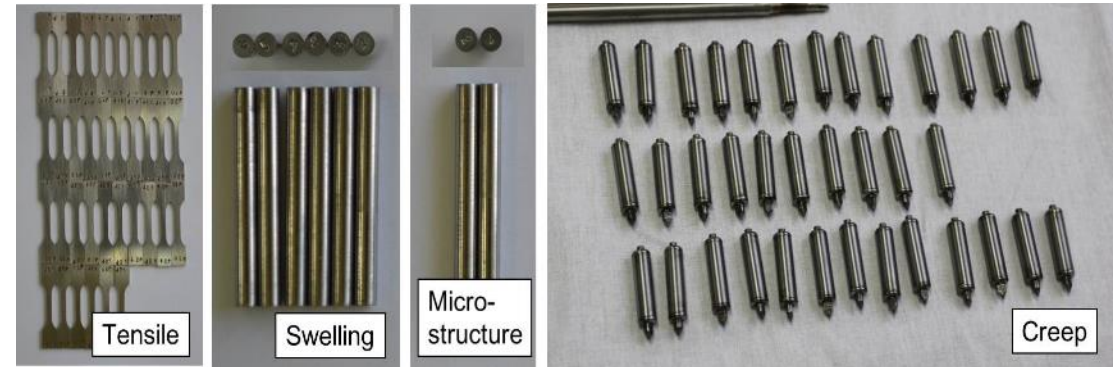

Irradiation test specimens



Irradiation test rig

- ❑ Results
  - 2 Interim inspections and final inspections
  - Inspection items
    - Creep : diametral strain measurement
    - Swelling : Density measurement



Interim inspection



# Fuel Cladding Chemical Interaction(FCCI) Tests

- ❑ Comparative FCCI test of FC92 and HT9 cladding
  - 650~800°C for 1~5,000hr
  - FC92 cladding showed FCCI behavior similar to HT9 with fresh fuel above 700°C
- ❑ FCCI test using the irradiated fuel
  - U-10Zr-5Ce/T92 from HANARO-irradiated fuels
  - FCCI tests under high vacuum at high temperature
  - Eutectic melting region was observed at 800 °C

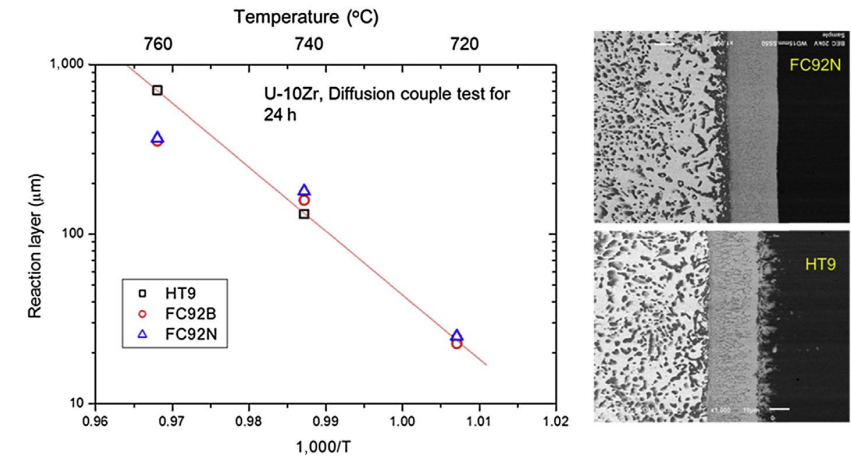

FCCI data of HT9 and FC92 with fresh U-10Zr

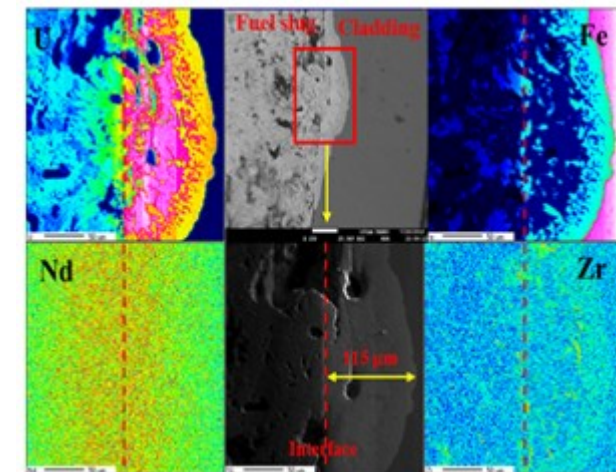

FCCI test of irradiated metal fuel

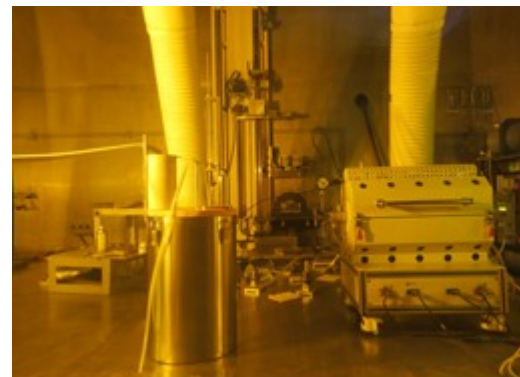

# Hydraulic Test of Fuel Assembly

- ❑ Test facility : HyTeL-SF
  - Hydraulic test using a full size FA
  - Operation conditions:
    - 70°C, 2MPa, 180 m<sup>3</sup>/hr
  
- ❑ Fuel assembly hydraulic tests
  - Measurements of FA pressure drop
    - Tested under the same Reynold number of Na
  - FA hydraulic lift-off and hold-down test
  - Flow-induced vibration test

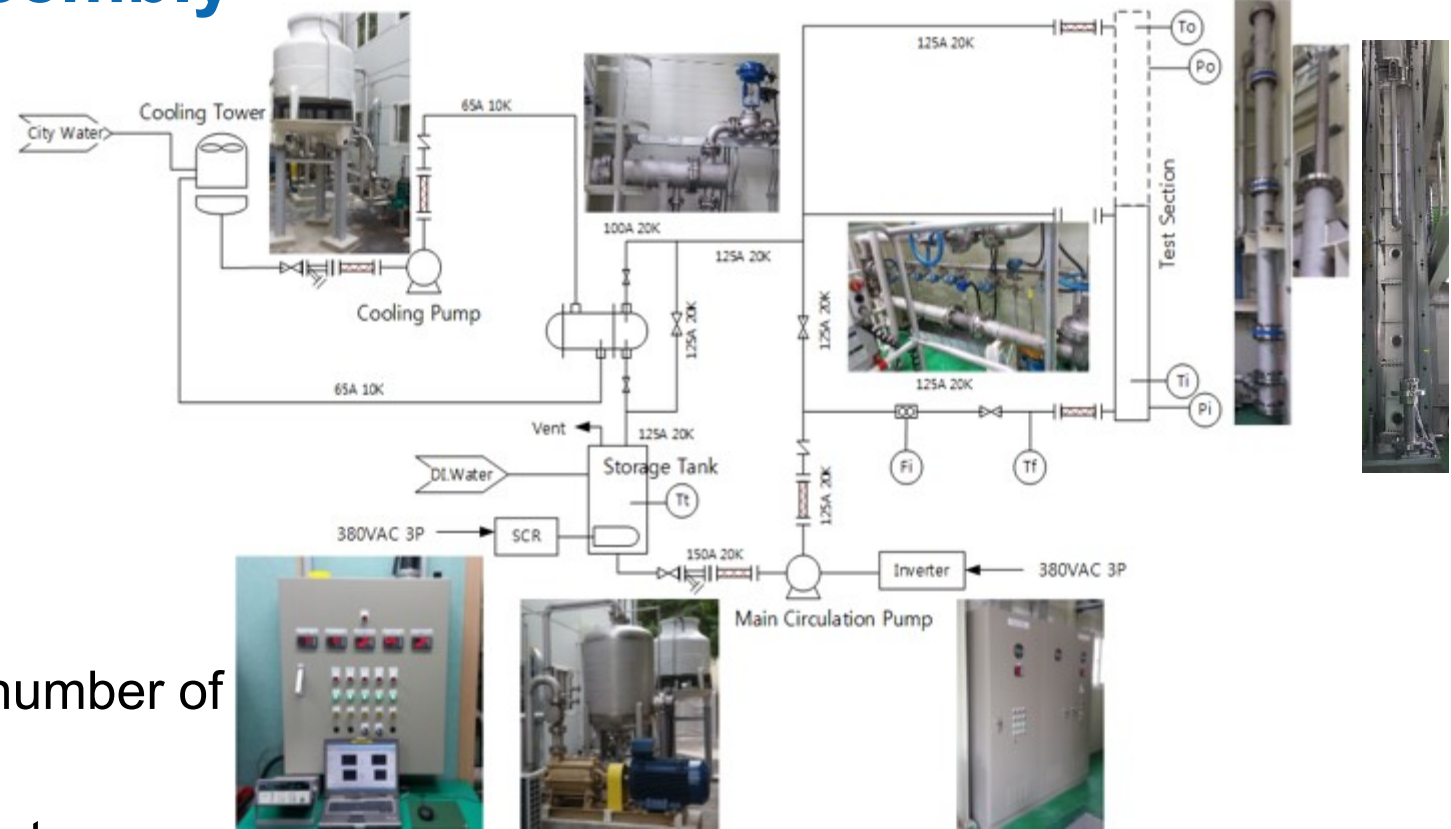

HyTeL-SF

# Mechanical Test of Fuel Assembly

- ❑ Test facility : FAMECT
  - Test bench for LWR and SFR fuel assembly
  
- ❑ Fuel assembly mechanical tests
  - Measurements of FA structural response
    - Vibration characteristics
    - Lateral bending
    - Axial impact (elastic)
  - Verification of FA structural integrity and functional requirements
    - Stress and strain measurement under max. withdrawal force of IVTM(In-Vessel Transport Machine)

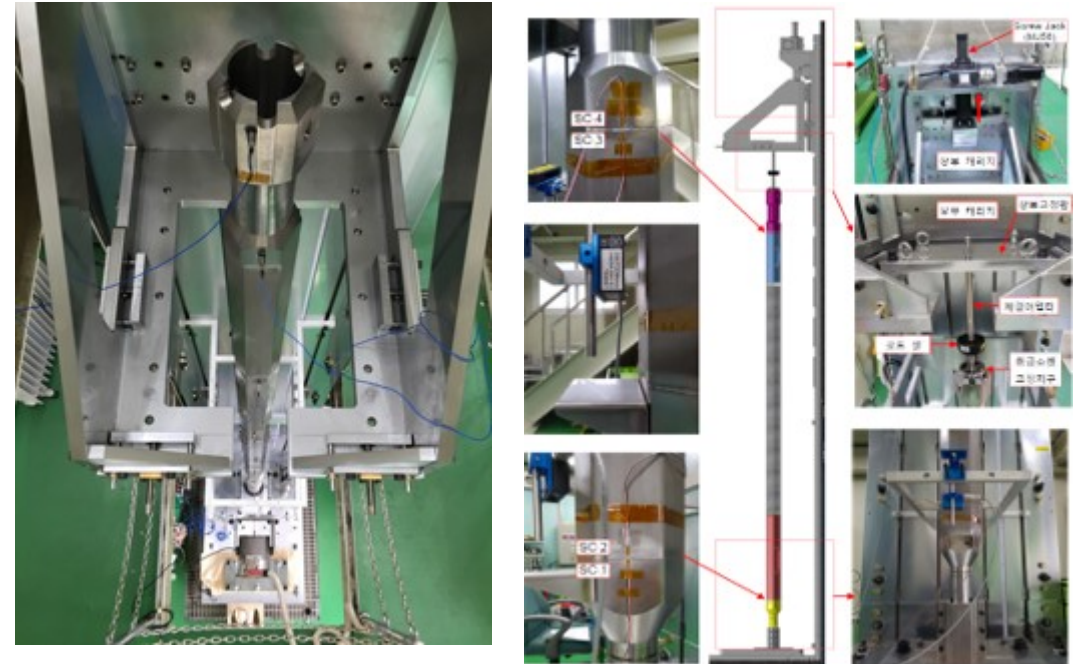

# TRU Metal Fuel Fabrication Process

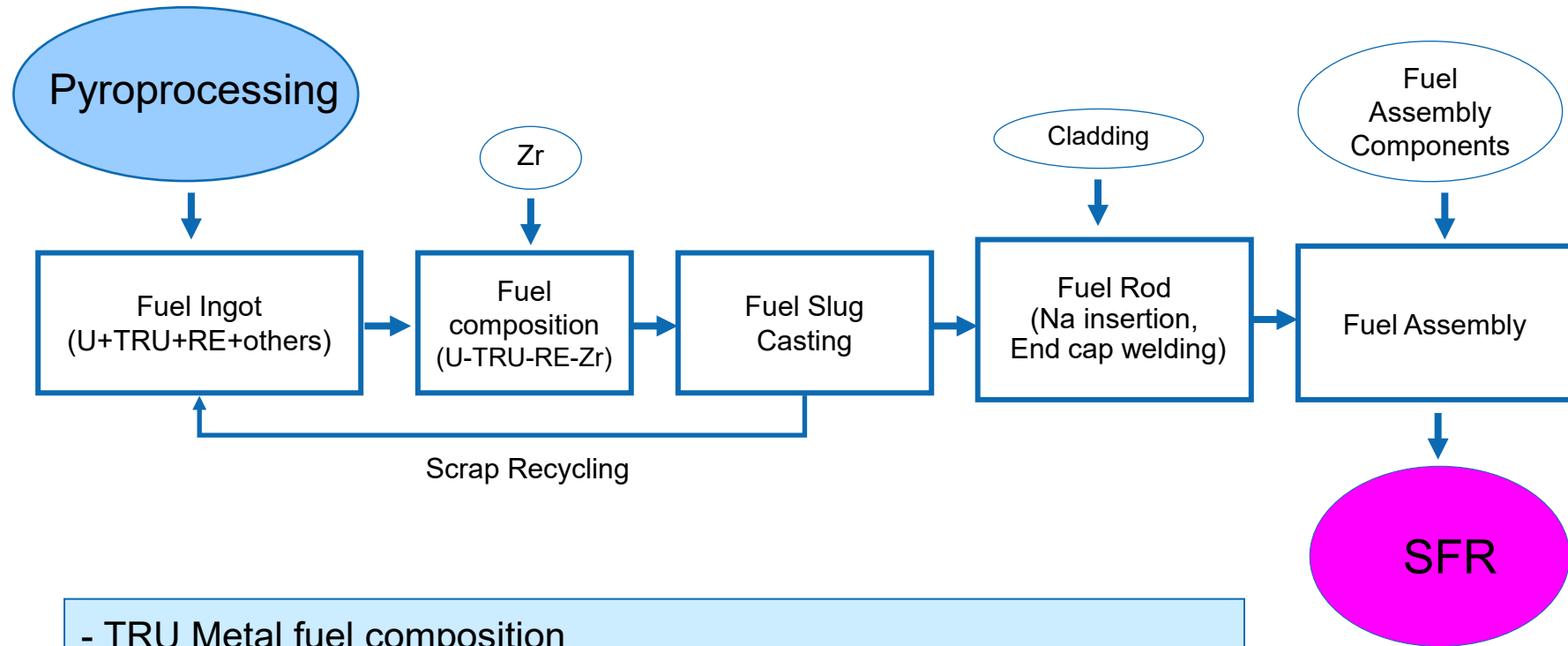

- TRU Metal fuel composition  
. U-Pu-MA(Np, Am, Cm)-RE(Nd 53%, Ce 25%, Pr 16 %, La 6%)-Zr

# Technical challenges of Recycling TRU Metal Fuel

- ❑ Remote fabrication of metal fuel with radioactive minor actinides
  - Control of Am vaporization and chemically active rare earth elements during metal fuel casting
  - Reliable, simple and automatic remote hot cell fuel fabrication
- ❑ Verification of Irradiation performance of U-TRU-RE-Zr metal fuel
  - Effects of minor actinides and rare earths on fuel performance
  - Performance verification up to high burnup
  - Barrier technology development to prevent interaction between metal fuel and metal cladding
- ❑ Advanced cladding for high burnup and high temperature
  - High strength FMS (ferritic-martensitic steel) cladding

# Composition of PWR Spent Fuel

Contents of 1 ton (~ 2 fuel assemblies) after cooling for 40 years



955.4 kg U  
7.8 kg Pu (5.1 kg  $^{239}\text{Pu}$ )  
0.6 kg Np  
1.6 kg Am  
0.02 kg Cm  
34.7 kg fission products

Fission Products:  
10.1 kg Lanthanides  
0.5 kg  $^{137}\text{Cs}$   
0.2 kg  $^{129}\text{I}$   
0.8 kg  $^{99}\text{Tc}$   
0.006 kg  $^{79}\text{Se}$   
0.3 kg  $^{135}\text{Cs}$   
3.4 kg Mo isotopes  
2.2 kg Ru isotopes  
0.4 kg Rh isotopes  
1.4 kg Pd isotopes

# Remote fuel fabrication

## Remote fuel fabrication process based upon injection casting

- Remote casting furnace and mock-up test facility were installed to develop the remote fuel fabrication process.
- Seventy-eight fuel slugs (U-10Zr) fabricated simultaneously through remote injection casting were confirmed to satisfy the fabrication specification.

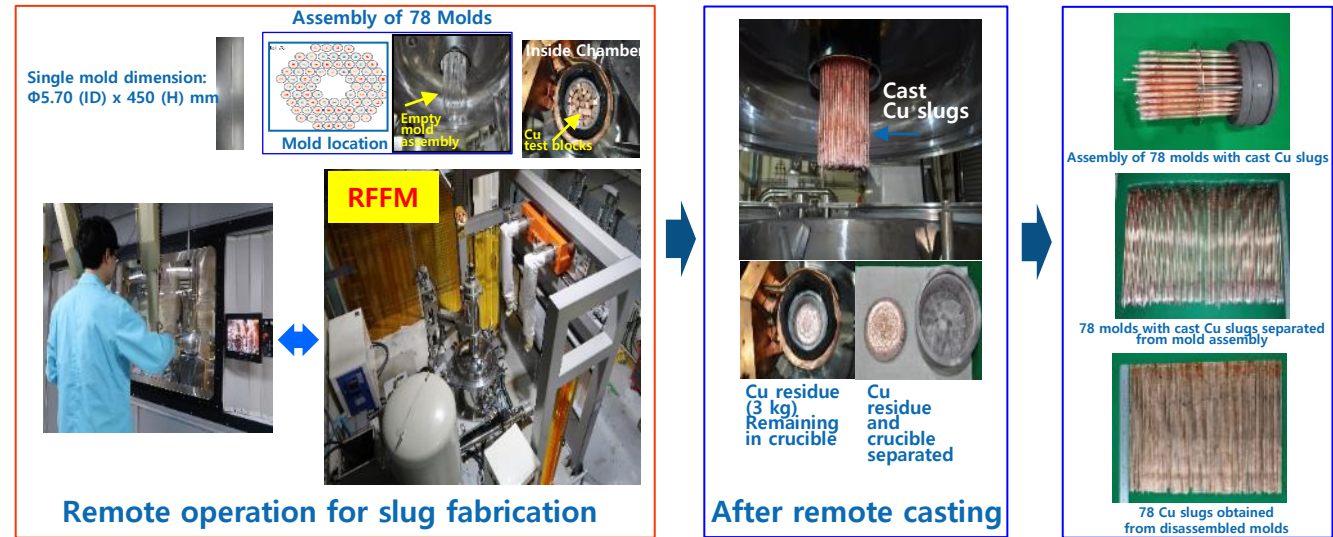

Cu-Ni alloy slugs



U-10wt.%Zr fuel slugs

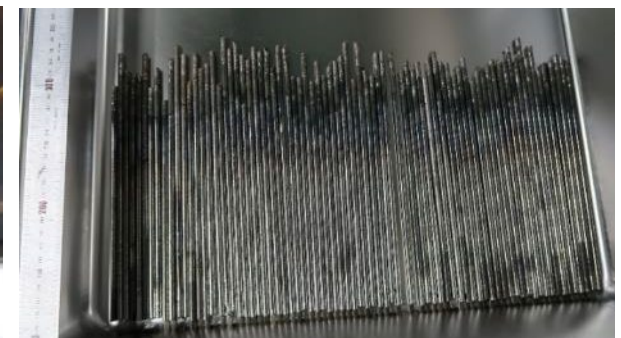

# Particulate Fuel

- ❑ Particulate fuel concept
  - Fuel particle fabrication followed by vibro-compaction or consolidation of fuel particles
- ❑ Fabrication of atomized particles
  - U-10wt%Zr fuel particles were fabricated by atomization process
  - Particle size : avg. 65 $\mu$ m and 350 $\mu$ m

- ❑ Advantages
  - Low FCMI
  - Fuel without Na bond(potential)
  - Process loss reduction
  - Mold not needed
- ❑ Plan
  - Irradiation test in HANARO

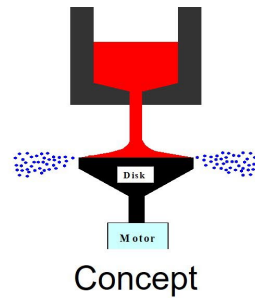
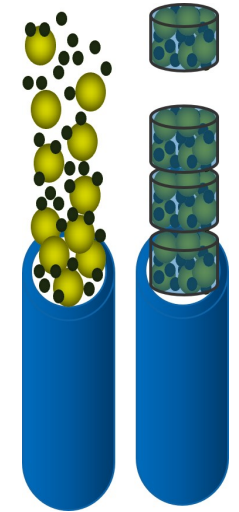

Atomization

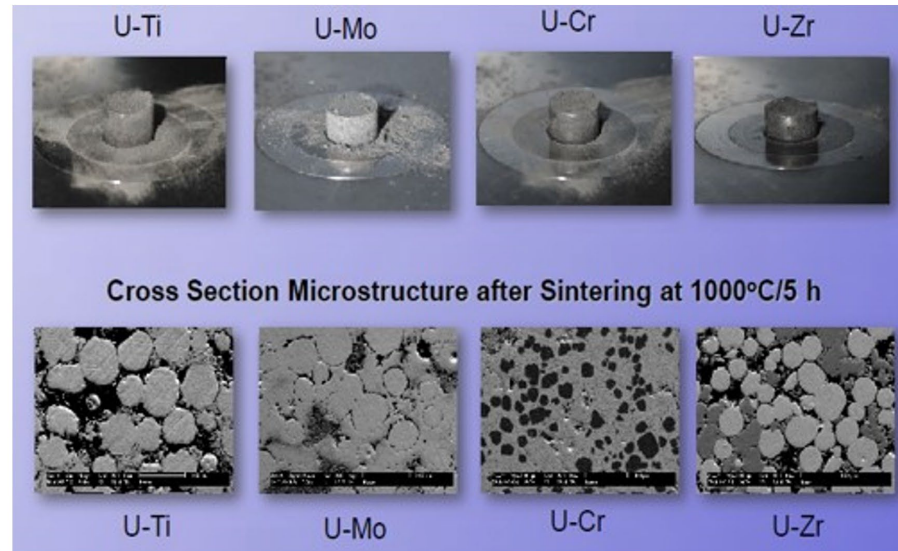

Sintering of various atomized powders

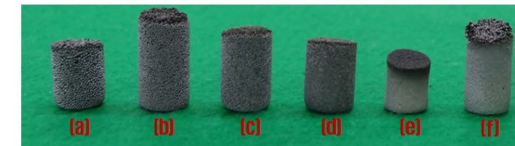
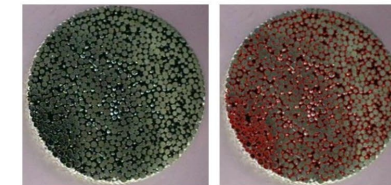
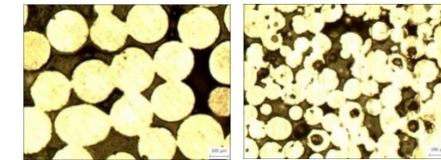

Sintered pellets of U-10Zr



# Annular Fuel Slug

## ❑ Fabrication of annular fuel slug by extrusion method

- The extrusion using Cu as a surrogate of U was carried out to derive the optimum conditions for annular fuel extrusion



Extrusion of Cu (annular)

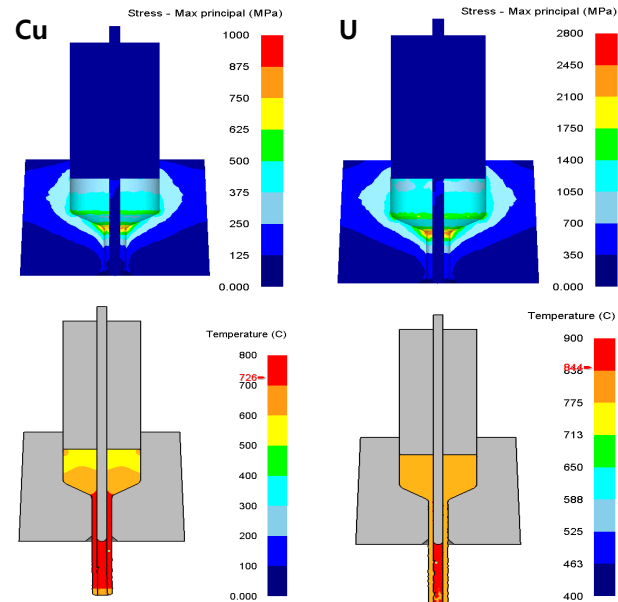

Simulation for annular fuel extrusion of Cu & U



Fabrication of annular fuel(Cu)

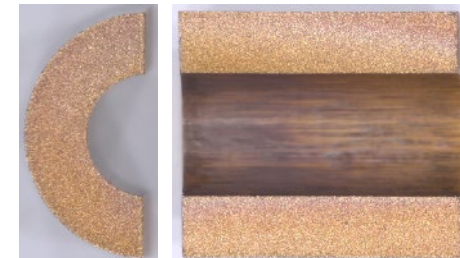

Defect analysis (Stereoscope)

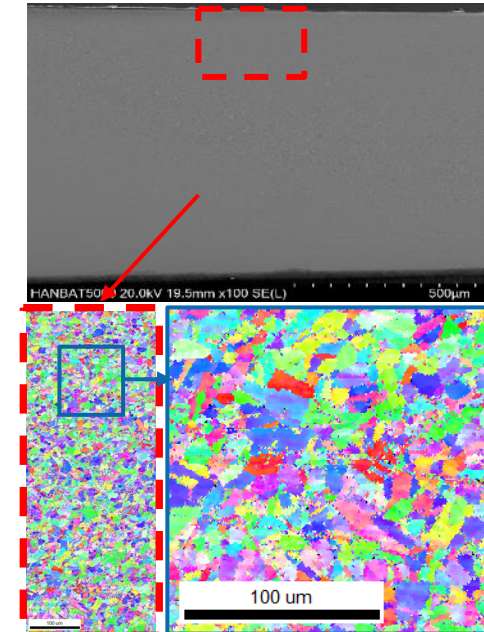

Microstructure analysis (EBSD)

# Liner cladding

- ❑ Liner cladding tube to prevent fuel-cladding chemical interaction (FCCI)
- ❑ Liner cladding fabrication
  - Parameter evaluation
    - Cold work process : drawing, pilgering
    - Selection of cold working ratio / Intermediate heat treatment
  - Fabrication of liner cladding
    - 50 $\mu$ m thick liner cladding tube(~1m) by co-drawing HT9 and liner(Zry-4, Ti)

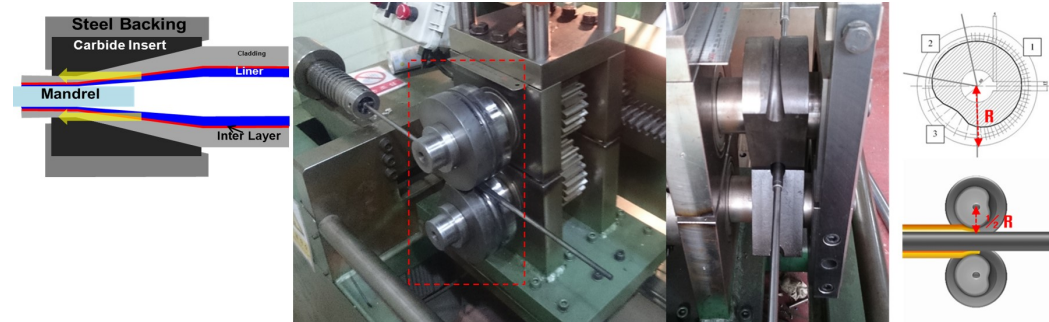

Pilger process of liner cladding tube

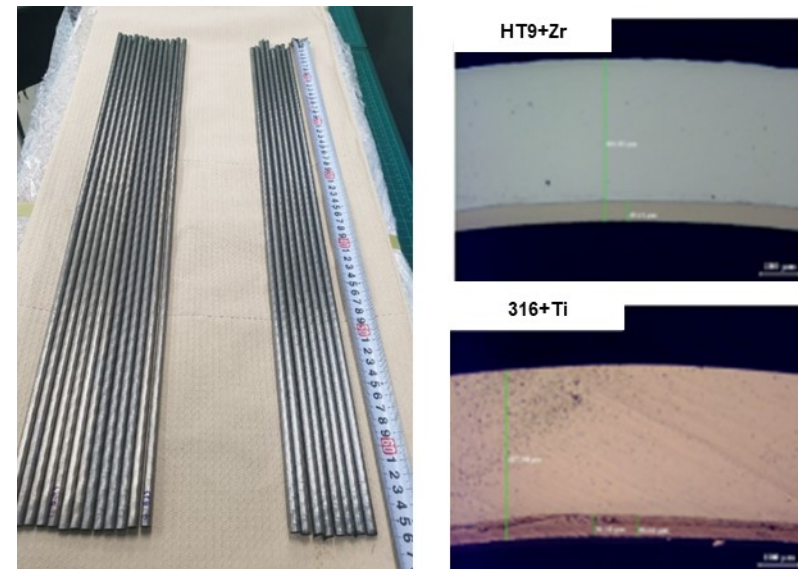

Liner cladding

# Summary

## ❑ Metal fuel for PGSFR

- U-Zr driver fuel for an initial core and U-TRU-Zr fuel for transmutation
- Fuel design, fabrication, and verification tests were performed.
- Technical feasibility of TRU fuel recycling in SFR was shown.

## ❑ PGSFR coupled with pyro-electrochemical processing can provide a solution for PWR spent fuel management

- R&D to provide technical information to the decision makers
- The direction of pyro-SFR technology development will be decided in 2021.

# Thank You 감사합니다



# Upcoming Webinars

| Date             | Title  | Presenter   |
|------------------|--|---|
| 18 November 2021 | Geometry Design and Transient Simulation of a Heat Pipe Micro Reactor  | Dr. Jun Wang, University Of Wisconsin, Madison, USA |
| 15 December 2021 | Development of an Austenitic/Martensitic Gradient Steel by Additive Manufacturing  | Dr. Flore Villaret, EDF, France                     |
| 27 January 2022  | ESFR SMART a European Sodium Fast Reactor Concept including the European Feedback Experience and the New Safety Commitments following Fukushima Accident | Mr. Joel Guidez, CEA, France                        |

# Evaluation of SFR Fuels

|                         | Oxide   | Metal   | Nitride   | Carbide  |
|-------------------------|---|---|---|--|
| Irradiation performance | Proven up to 15 % BU  | Proven up to 20 % BU  | Need verification   | Need verification  |
| Fuel Fabrication        | MOX fabrication in glove box commercially verified<br>Research on MOX fabrication in hot cell | Fuel fabrication in hot cell verified in small scale (EBR-II)   | Research  | Research   |
| Fuel Recycling          | Aqueous (verified)<br>Pyro-electrochemical (research)   | Pyro-electrochemical (research)<br>Aqueous (potential)  | Aqueous (potential)<br>Pyro-electrochemical (potential)                             | Aqueous (potential)  |
| Merit                   | Irradiation performance and aqueous recycling verified  | Irradiation performance verified<br>Compatibility with sodium<br>Inherent passive safety<br>Simple fuel fabrication | Compatibility with sodium<br>High melting temperature and high thermal conductivity | Compatibility with sodium<br>High melting temperature and high thermal conductivity          |
| Demerit                 | Reaction with sodium<br>Fuel cladding chemical interaction                                    | Fuel cladding chemical interaction<br>Pyro-electrochemical recycling needs to be verified                           | Fuel pellet swelling and cracking<br>Fuel cladding mechanical interaction           | Fuel pellet swelling and cracking<br>Fuel cladding mechanical interaction<br>C-14 activation |
| Technology Status       | Commercialization   | Near commercialization  | R&D   | R&D  |

# SFR Fuel Evaluation

## ☐ Oxide Fuel

- Commercialization of MOX fuel in SFR and aqueous reprocessing of LWR fuel
- Reaction of MOX and sodium coolant may limit reactor operation flexibility

## ☐ Metal Fuel

- Verified irradiation performance(U-Pu-Zr) and excellent compatibility with sodium
- Pyro-electrochemical fuel recycling needs to be demonstrated
- Selected as the fuel for the innovative SFR(PGSFR, Natrium/TWR, 4S) with longer cycle length

## ☐ Nitride and Carbide Fuels

- Very good thermal properties(high melting temperature and thermal conductivity)
- Irradiation performance and fuel recycling need to be verified

# SFR Metal Fuel Evaluation Parameters

## ☐ Fuel fabrication

- Remote fuel fabrication : reliability, simplicity and maintenance
- Control of volatile element transport during fuel fabrication

## ☐ Fuel performance

- Fuel integrity up to high burnup
- Effect of MA and RE on fuel performance
- Allowance of impurities in fuel from pyro-processing of irradiated fuel

## ☐ Reactor safety

- Demonstration of passive safety
- Compatibility with sodium coolant : Post-fuel failure behavior
- Fuel behavior under DBA and HCDA

## ☐ Economy

- Fuel cycle cost : fuel cost, fuel recycling cost, waste disposal cost
- Reactor cost : construction and operation costs



# Fuel Rod Design

## PGSFR Fuel Rod

- Fuel/cladding material: U-Zr/FMS
- Fuel rod length: 2,240 mm
- Active fuel length: 900 mm
- Fuel slug diameter: 5.54 mm
- Cladding diameter & thickness: 7.4 mm & 0.5 mm

## Fuel Performance Analysis

- Deterministic approach
  - Uncertainties of reactor operation, fuel fabrication and performance models are taken into account.
  - The uncertainties are combined by a root mean square method
  - Limiting rods were selected
    - Inner core: highest linear power
    - Outer core: longest residence time

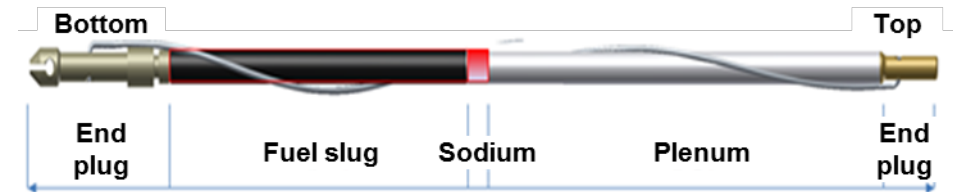

### Fuel Design Criteria

|            | Acceptance Criteria  | Specified Limits   |
|------------|--|--|
| NO and AOO | No fuel pin failure  | CDF<0.05<br>Strain<1%  |
| DBA-1      | A small fraction of fuel pin failure                             | CDF (Single most-damaging DBA-1)<0.05<br>Strain (Single most-damaging DBA-1) <1% |
| DBA-2      | Fuel pin coolable geometry, with no fuel pin failure propagation | Fuel temperature<Solidus<br>Cladding Temperature < 1,075°C                       |
| DEC        | Core coolability with in-vessel retention                        | Coolant Temperature < Sodium Boiling   |

# Metal fuel rod performance analysis code

## ❑ PUMA

- Performance of Uranium Metal fuel rod Analysis code
  - Applicable only to metal fuel
  - Mechanistic models are employed

## ❑ Code structure

- 1D FE-based thermal & mechanical modules
  - Thermal analysis is followed by mechanical analysis
- Coupling between thermal and mechanical analyses
- Models such as fission gas release and element redistribution were incorporated

## ❑ Code verification and validation

- Comparison of code prediction with fuel performance test data and prediction of other codes is going on.

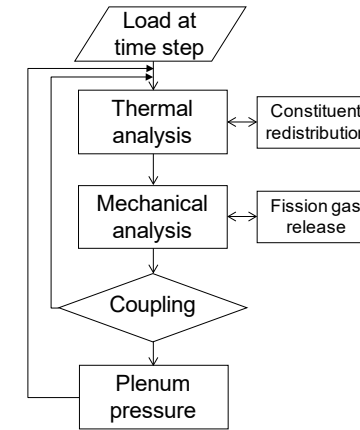

Iteration scheme

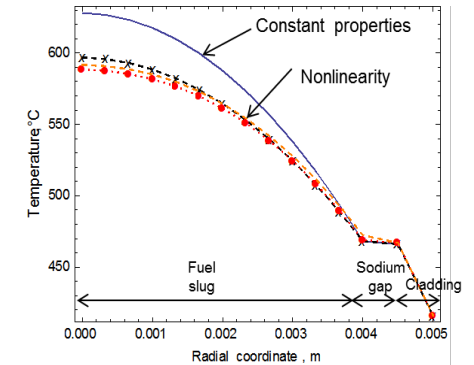

Verification of thermal analysis

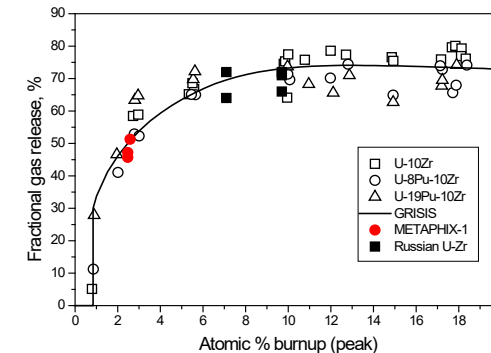

Fission Gas Release

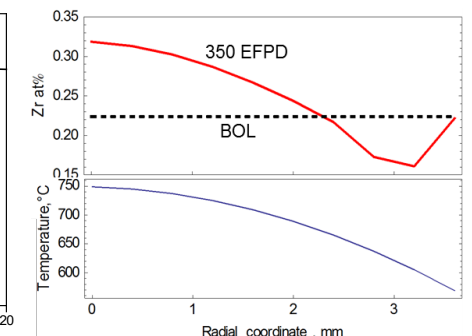

Fuel constituent redistribution analysis

# Investigation on Cladding Tube Fabrication Process

- ❑ Mother plate preparation
  - Heat treatment conditions
    - Normalizing at 1050°C for 1 hour
    - Tempering at 750°C : mother plate 1
    - Tempering at 550°C : mother plate 2
- ❑ Cold rolling
  - Cold rolling : 4mm to 1mm
  - Cold rolling times : 1 to 7
- ❑ Heat treatment
  - Temperature : 700°C
  - Total heat treatment time : 30min
- ❑ Microstructure
  - As cold rolling pass increased, fine precipitates uniformly distributed.
- ❑ Tensile test
  - As cold rolling pass increased, the yield and tensile strength increased.

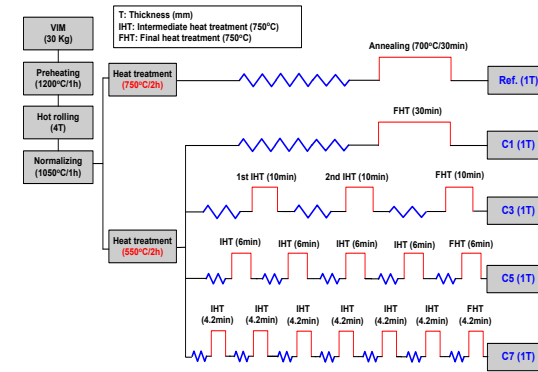

Cold rolling procedure

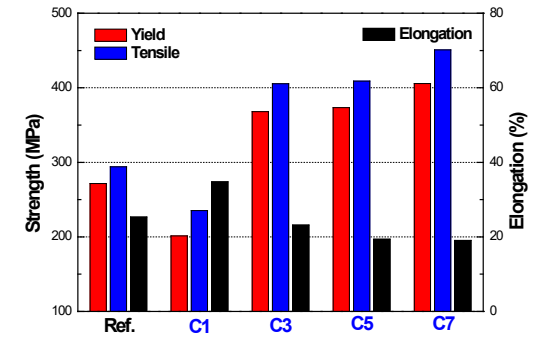

Strength

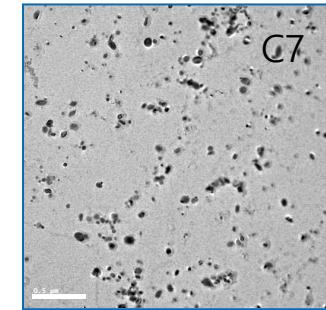
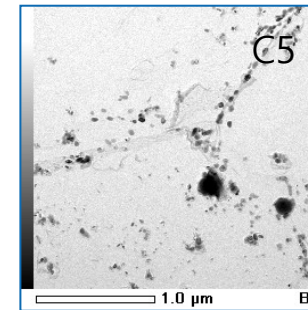
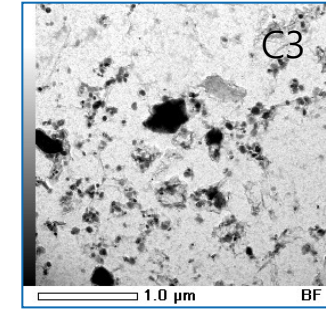
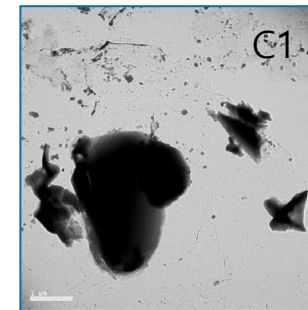

Microstructure